



**STATEWIDE**

HOME HEALTH CARE

**Independent living and  
rehabilitation equipment.**



Your home. Your health. We care.

**PRODUCT CATALOGUE**

*"At Statewide, we pride ourselves on our ability to understand our product offering: customer service. The experience of our customers is the most crucial element of what we do. Some of the decisions our customers make can be life-changing.*

*By constantly renewing and improving our range, we ensure that our clients have access to the latest products. These products have been carefully sourced and tested to ensure that they meet all the necessary national and international standards. We pride ourselves on our product range, pricing and the way our knowledgeable and experienced staff are able to assist health professionals, patients, family members and carers. We never take for granted the positive impact we can make through the products we offer. "*

**Managing Director Timothy D Cohen**



*Statewide Home Health Care is a family-owned business that grew from a small section of Rodney Cohen's Acland Street Pharmacy. Originally named St Kilda Home Health Care, the store opened in 1992 and was based in Barkly Street, St Kilda (Melbourne) just around the corner from the original pharmacy.*

*In 1995, Rodney's son Timothy took over the business. He renamed the store and moved it to the present location at 501 Nepean Highway, Brighton East. In December 2009 Peninsula Home Health Care was opened in Seaford to deliver product solutions to the Mornington Peninsula and the Westernport area.*

*Statewide have an excellent reputation in the Healthcare sector for providing their unsurpassed brand of customer service, coupled with product solutions to Allied Health Professionals, their patients and the general public.*

*The business' expertise extends to equipment hire, trials, mobile equipment repair service, home modifications (rail installation services), and web based ordering solutions.*

*Statewide staff strive to recommend the most suitable equipment whatever your requirements and when appropriate will always refer clients to health professionals.*

*Whatever your needs, be assured that the Team at Statewide Home Health Care will always provide courteous, patient and informed customer service.*

*Statewide offers complimentary delivery to hospitals that are a party to our service agreements. For a minimal charge, we offer same-day delivery service throughout the Melbourne Metropolitan Area.*

*If you're a health professional, carer, key decision maker or responsible for your facility's procurement, you will find this catalogue a helpful resource. Patients, family and carers are welcome to visit our modern and spacious showroom to experience first-hand the extensive range of Home Health Care products on offer.*

*This catalogue provides a detailed overview of our product range. Visit [www.shhc.com.au](http://www.shhc.com.au) to peruse the Statewide website which provides in-depth product specifications, and an online shopping solution with delivery throughout Australia.*

# USEFUL INFORMATION

## ***On-line Ordering***

The general public are welcome to order from our Ecommerce store located on our website. For Health professionals, we have developed a suite of on-line ordering tools that can also be accessed through our website.

## ***Showrooms***

Patients, family, healthcare professionals and carers are welcome to visit our modern and spacious showrooms to browse through our extensive range of Home Health Care products.

## ***Hire Equipment***

We offer the most comprehensive rehabilitation equipment hire service in Melbourne, the Mornington Peninsula and Westernport region. All of our equipment is sanitized after every use with Hospital Grade disinfectant. Our customer service team are always on hand to discuss your booking with you.

## ***Grab rails and Home Modifications***

Our registered builder is available to provide a range of Home modification services across the Melbourne Metropolitan area, the Mornington Peninsula and Westernport region. The service includes the installation of grab rails, Magnetic door catches, Shower screens and hand held showers.

## ***Logistics Management***

We offer a timely delivery service throughout Australia. By managing your order all the way to your door, we ensure that every aspect of the transport arrangements runs smoothly.

## ***Repairs***

Our repairs department is always available to assist. We specialise in both workshop and mobile servicing and repair of rehab equipment including power chairs, pressure mattresses, hoist, electric beds, mobility aids and bathroom equipment.

## ***Department of Veterans Affairs***

We have been proudly serving the Veteran Community for more than 20 Years. By joining forces with Brightsky Australia we can assist you with the provision of any product available under the Rehabilitation Appliance Program.

## ***Equipment Trials***

We provide complimentary equipment trials for the majority of our Medical Equipment. This offers patients, carers and health professionals the chance to evaluate the clinical outcomes provided by the introduction of equipment into the care environment.

## ***Equipment Installation***

If you are ordering a larger item, like a Hospital Bed, Hoist, Electric Recliner or Air Alternating Air Mattress, our Installation team are always on hand to assist.

## ***National Disability Insurance Scheme***

As a registered NDIS provider, we have the frame work in place to support you in reaching your goals and welcome the opportunity to discuss your needs in more detail.



# PAGE DIRECTORY

<b>MOBILITY</b>	<b>3-16</b>
<i>Walkers, Rollators, Walking Frames, Walking Sticks, Crutches, Knee Walkers, Wheelchairs &amp; Accessories</i>	
<b>PRESSURE CARE CUSHIONS</b>	<b>17-19</b>
<i>Roho, Equagel, Jay, Spenco</i>	
<b>RAMPS</b>	<b>20-21</b>
<i>Silverstar, Decpac</i>	
<b>POWERED MOBILITY</b>	<b>22-26</b>
<i>Mobility Scooters, Power Chairs, Accessories</i>	
<b>BATHROOM</b>	<b>27-30</b>
<i>Shower Chairs, Stools, Bath and Showering Accessories</i>	
<b>TOILETING SOLUTIONS</b>	<b>31-36</b>
<i>Over Toilet Frames, Raised Toilet Seats, Bedside Commodes, Transporter Commodes</i>	
<b>BARIATRIC PRODUCTS</b>	<b>37</b>
<i>Walkers, Commodes, Wheelchairs, Walking Frames, Over Toilet Seats, Shower Stools, Crutches, Seating</i>	
<b>PAEDIATRIC PRODUCTS</b>	<b>38</b>
<i>Crutches, Walkers, Wheelchairs, Ramps, Cushions</i>	
<b>BEDS &amp; MATTRESSES</b>	<b>39-50</b>
<i>Healthcare Beds, Volker Range, Floorline Beds, Endless Healthcare Bed, Bariatric Bed, Static Mattresses, Air Alternating Mattresses, Medical Sheepskins, Foam Overlays</i>	
<b>SKIN PROTECTION &amp; COMFORT</b>	<b>51-53</b>
<i>Sheer Comfort Sheepskin Products, Skin Protection, Hip Savers</i>	
<b>BEDROOM ACCESSORIES</b>	<b>54-55</b>
<i>Bed Poles, Cradles, Clamp on Bed sticks, Over Bed Tables</i>	
<b>SEATING</b>	<b>56-58</b>
<i>Height Adjustable seating, Support Chairs, Pressure Care Chairs, Air Chairs</i>	
<b>PATIENT TRANSFER</b>	<b>59-64</b>
<i>Lifting and Standing Hoists, Slings, Manual Transferring Aids, Sit to Stand Transferring aids</i>	
<b>FALLS PREVENTION</b>	<b>65-68</b>
<i>Sensor Alarm Floor Mats, Bed and Chair Pads, Monitors</i>	
<b>ALARMS, COMMUNICATION &amp; TECHNOLOGY</b>	<b>69-73</b>
<i>Large Button Phones, Alarm Clocks and Sensor Lighting, Mind Me Personal Alarms</i>	
<b>MAGNIFIERS</b>	<b>74</b>
<i>Reading Magnifier Range</i>	
<b>PERFECT PETZZZ</b>	<b>75</b>
<i>Lifelike pets for companionship</i>	
<b>AIDS FOR DAILY LIVING</b>	<b>76-77</b>
<i>Dressing and Grooming Aids, Bathing accessories, Grip Sox</i>	
<b>DINING &amp; KITCHEN</b>	<b>78-79</b>
<i>Independent Eating Utensils, Kitchen Gadgets, Tap Turners, Can Openers</i>	
<b>SAEBO PRODUCTS</b>	<b>80</b>
<i>Saebo Glove, Saebo Stretch, Saebo Step</i>	
<b>HOUSEHOLD AIDS - REACHERS</b>	<b>81</b>
<i>Kitchen trolley, kitchen stool, leg lifters, swivel cushions, reachers, key turners, handybar</i>	
<b>FITNESS &amp; MASSAGE</b>	<b>82-83</b>
<i>Exercise Equipment, Massage Aids</i>	
<b>SPORTS MEDICINE RANGE</b>	<b>84-85</b>
<i>Bioskin Premium Bracing</i>	
<b>THERAPEUTIC PILLOWS</b>	<b>86-87</b>
<i>Back Supports, Sitting Cushions, Positioning Wedges, Sleeping Pillows, Travel Pillows</i>	
<b>HEALTH &amp; WELLBEING</b>	<b>88-91</b>
<i>Heat Wheat Range, Vulcan Therapeutic Bracing, Beurer Health Products</i>	
<b>COMPRESSION STOCKINGS</b>	<b>92</b>
<i>Class I and Class II compression stockings, Donning Aids, Travel Socks</i>	

## *KEEP MOVING - MAINTAIN INDEPENDENCE*

*Our range of walking frames cater to a wide range of needs offering independence and safety.*

### **Dynamic Four Wheel A-Frame Plus**

This versatile and lightweight four wheel walker has 8 inch castors and a locking handle brake mechanism. All walkers come standard with padded seat and curved ergonomic back supports.

The Dynamic Range of wheeled walking frames provides increased support when walking.

Unlike static frames, they allow the user to maintain a normal walking pattern and speed.

*All the walkers fold easily for storage and transport.*



#### **Mini** 15-0305M

Handle height: 70 cm - 79 cm  
 Seat height: 45 cm  
 Max. User weight: 125kg  
 Product Weight: 7kg

#### **Standard** 15-0302 GREEN, 15-0303 RED, 15-0304 BLUE.

Handle Height: 80 cm - 91 cm  
 Seat Height: 55 cm  
 Max. User weight: 125kg  
 Product Weight: 7kg

#### **Tall** 15-0305T

Handle Height: 85 cm - 96 cm  
 Seat Height: 60 cm  
 Max. User weight: 125kg  
 Product Weight: 7kg

## Rollator Economy

Powder coated red aluminium frame designed predominately for indoor use.



- 4 x Solid 6" (15cm) Wheels
- Handle height: 72cm - 86cm (25mm Increments)
- Seat height: 49 cm
- Handle height: 72 cm - 86 cm (25mm Increments)
- Max. User Weight Capacity: 120kg
- Product Weight: 6kg

## Elite Mini

The Mini Elite is a light weight, durable aluminium folding walking frame. It is lower and narrower than a standard walker. It comes with a removable basket and folding backrest for easy storage.



- 4 x Solid 6" (15cm) Wheels
- Handle height: 72cm - 85cm
- Overall width: 52cm
- Seat height: 48cm
- Max. User weight: 130kg
- Product Weight: 6kg

## The Revo Walker

This extremely lightweight walker has a cross bar design making it easy to fold and lift. It provides plenty of stability and reliability. The Revo walker comes standard with pouch and cane holder.



### Standard

- Handle Height: 79 cm - 95 cm
- Overall Width: 61 cm
- Seat Height: 58 cm
- Product Weight: 6 kg
- Max. User Weight: 150kg



### Mini

- Handle Height: 76 cm - 86 cm
- Overall width: 56 cm
- Seat Height: 48 cm
- Product Weight: 6kg
- Max. User Weight: 150kg



Feeling good, staying active and enjoying life is important at any age. Airgo® mobility products provide the freedom, security and confidence to stay active and go where you want to go.



150316

### Airgo® Adventure™ 8

Dual height frame technology. All Terrain, multipurpose Rollator.

Product Weight 7.35 kg.

Weight Cap. 136 kg



150322

### Airgo® Comfort Plus™

Lightweight Rollator suitable for indoor and outdoor use. Ergo seat and back with memory foam for enhanced comfort. Complete with extra large soft pouch under the seat which does not need to be removed when folding.

Product Weight 7.8kg

Weight Cap 136kg



### Airgo® Ultra-Light 6

**The lightest Rollator available:** a breeze to lift up and take anywhere!

This Rollator has a durable, ultra-light frame enabling you to lift the Rollator easily and take it anywhere.

Product Weight 4.75 kg.

Weight Cap 113 kg.



150325

### Airgo Fusion Rollator/Transport Chair

The Airgo Fusion is a lightweight Rollator which easily converts to a Transport Chair. Lightweight side-folding Rollator and transport chair in one design. Folds sideways easily by just a pull of the strap. Padded seat and a full backrest for superior comfort. Dual armrests provide a place to rest your arms in either mode. 8" (20 cm) Comfort-Grip wheels are ideal for indoor & outdoor use.

Weight capacity: 136kg. Product Weight: 7.7kg

**Let's Go (a)**

Has a removable tray for use as a food trolley, a small table to eat from, or as a support if you need to get up in the middle of the night.

(Available in Beech or Red & Black)

**Measurements and weight:**

Handle height:	78 to 96 cm
Length:	67 cm
Width:	58,5 cm
Distance between handles:	41 cm
Product Weight:	6.1 kg

**Let's Go Out (b)** Elegant, comfortable and steady. Simple to fold. Needs little space and stands by itself when folded.

Handle height:	83 to 94 cm
Tray height:	68 cm
Length:	63 cm
Width:	54 cm
Product Weight:	6.5 kg



**Mack Series** Heavy Duty Rollator Range)

**(a) Mini Mack**

Handle height:	74 cm - 85 cm
Seat height:	49 cm
Overall Width:	62 cm
Product Weight:	9kg
Maximum User weight:	150kg

**(b) Mighty Mack**

Handle height:	76 cm - 91 cm
Seat height:	54 cm
Overall Width:	71 cm
Product Weight:	12kg
Maximum User weight:	225kg



**(a) Vogue Rollator**

The stylish European designed Carbon Fibre Walkers are a lightweight and versatile range with a sturdy frame and easy-fold locking system,

Handle Height	66cm - 86cm
Seat Height	55cm
Overall width	60cm
Maximum user weight	150kg
Product weight	5kg

**(b) X Fold Rollator**

Light and portable the X Fold Rollator is lightweight and can be folded easily allowing it to fit into a car boot. Light and portable for easy transportation.

Handle Height	81cm - 94cm
Seat Height	56cm
Overall width	64cm
Maximum user weight	135kg
Product weight	8kg



**(c) Euro Rollator**

Powder coated aluminium frame designed for both indoor and outdoor use. Includes bag. Compact folding frame & cross bar allows for easy transport. **Folded Width: 23 cm**

Handle Height	79cm - 95cm
Seat Height	58cm
Overall width	61cm
Maximum user weight	136kg
Product weight	5.5kg





Patients stay happy, safe, comfortable and independent.



**Rollator**

Features an easy-to-operate ergonomic hand brake and a comfortable seat. This walker offers great manoeuvrability, stability and is height adjustable for custom fit. Basket and tray are standard.

**Adjustable Handle Height** 79-97cm  
**User Weight** 130kg



**Three Wheel Walker (with basket)**

Light weight walker built for greater comfort and use. Folds in the middle.

**Adjustable Handle Height** 81-94cm  
**User Weight** 115kg

**Accessories**

- Pouch 150500B
- Basket 150500A



**Rollator-Arthritic**

Provides assistance for those who have difficulty walking. Strong and sturdy, the steel frame helps the user who requires extra bilateral stability.

**Adjustable Cuff Height** 98-112cm  
**User Weight** 100kg



**Dynamic Gutter Frame**

Sturdy wheeled walking frame for mobility training and rehabilitation. Made from chrome plated steel. Available in folding and non-folding models. Two castors with forearm supports or pistol grips available. Rear glides can also be added to the rear of this frame for easier manoeuvrability.

**Adjustable Cuff Height** 93-123cm  
**User Weight** 110kg



**Heavy Duty Frame**  
Weight rated to 250kg



Alternative top with handlebar grips.  
Handle Bar only 151011



**Weight Activated A-Frame Walker**

This lightweight walker has 7 inch puncture proof tyres and is easy to manoeuvre. Downward pressure on the handles activates the rear brakes for safety.

**Adjustable Handle Height** 83-94cm  
**User Weight** 125kg

**Accessories for the Four Wheel A Frame Walker**



Pouch 150501

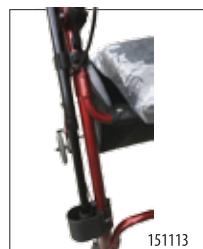

Walking Stick Holder 151113



Oxygen Tank Holder 150507

## Mobility aids such as frames are ideal for post-operative care by promoting independence

### THE 5150 RANGE

This Walking Frame is an ideal configuration for safe indoor mobilising. Configured with front castors and rear skis, the frame never leaves the ground. Manufactured in powder coated steel, it

is both strong and durable. All 5150's have been designed with angled side bracing to allow for support over the toilet. Beneficial for slow stream rehabilitation, and joint replacement patients.

**EXCLUSIVE TO  
STATEWIDE & PENINSULA  
HOME HEALTH  
CARE**



5150

150403

**Adjustable Handle Height** 78-90cm  
**User Weight** 160kg  
**Domestic Use**



5150 HD

150403HD

**Adjustable Handle Height** 78-90cm  
**User Weight** 160kg  
**Institutional Use**



5150 X T

150403T

**Adjustable Handle Height** 86-98cm  
**User Weight** 160kg  
**Institutional Use**

Plastic moulded handles for infection control



150416

**Folding**  
These frames are height adjustable and lightweight construction. Both Frames can be configured with wheels and glides to suit your individual requirements.  
**Available in Small: 5' - 5'6", Medium: 5'3"-5'8" and Large: 5'8"-6'1".**  
**User Weight: 127kg**



150410

**Non-Folding**



150413

**Walking Frame with glides & wheels**  
**Available in Small: 67-76cm, Med: 76-84cm and Tall: 87-94.**  
**User Weight: 127kg**



150402

**Deluxe Foldable Walking Frame**  
Height adjustable, general purpose walking frame is lightweight.  
**Available in Med: 79-89cm**  
**User Weight: 150kg**

## WALKING FRAMES ACCESSORIES



150515

DV22400

Rear Glides ST-ADLRG  
Rear Skis ST-GE20  
Front Wheels



150510



150522

By adding wheels and glides you can easily change the functionality of your walking frame.

# Walking Sticks

# Quad Sticks



- 1/ Aluminium Adjustable Coopers
- 2/ Crook Handle (Wooden)
- 3/ Crook Handle (Aluminium)
- 4/ Bronze Aluminium & Wooden Handle
- 5/ Wooden T Handle
- 6/ Floral Walking Stick (Folding)
- 7/ Folding Adjustable

- 8/ Airgo Comfort Plus Offset
- 9/ Airgo Comfort Plus Floral
- 10/ Airgo Comfort Plus Derby
- 11/ Airgo Comfort Plus w/Mini Quad Tip
- 12/ Airgo Comfort Plus w/Mini Quad Tip

- 1/ Three-Point Stick
- 2/ Airgo Quad Cane S
- 3/ Medium Base
- 4/ Palm-Grip Walking Stick Rh/Lh
- 5/ Quad Pod Stick Stabiliser
- 6/ Frog Holder
- 7/ Stick Leash

*Our walking aids are strong and durable. Designed for people who require more stability and security.*

# Crutches

Our crutches are easy to adjust. There are no tricky nuts and bolts to contend with, simply press a button and you can easily adjust the height for maximum user comfort. Sizes range from Child, Youth, Adult and Adult Tall.



1

\*180kg

150114

2

\*136kg

150111

3

\*249kg

150117

\* Recommended User Weight.



\*110kg

150106

\*127kg

150113



6

150200



**1/ Forearm Crutches** Specifically designed handles allow for even pressure distribution on and around the hand.

Available in Small: 4'7"-5'5", Medium: 5'4"-6'1" and Large: 5'6"-6'3".

**2/ Dynamic Under Arm Crutches (Axilla)** These crutches are standard with high-density rubber cushions and handgrips.

Available in Child: 4'-4'8", Youth: 4'7"-5'3" Medium: 5'2"-5'10" and Large: 5'10"-6'6".

**3/ Bariatric Under Arm Crutches** These crutches are standard with high-density rubber cushions and handgrips that provide long wear and greater comfort.

Available in Regular: 5'2"-5'10", Tall: 5'10"-6'6".

**4/ Ergonomic Handle Crutches** This crutch has a specially designed handle that allows greater pressure distribution.

Available in Small: 4'11"-5'8", Medium: 5'2"-5'11", Large: 5'6"-6'3" & X Large: 5'9"-6'6".

**5/ Gutter Crutches** These have a lightweight aluminium stem and a padded vinyl-covered gutter that provides maximum comfort to arthritic users. Gutter Height: 88-116cm.

**6/ Comfy Crutches (pair)** Cushion set designed to improve the comfort of Underarm crutches by fitting soft foam inserts over the top of the existing crutch underarm pads and handgrips.

## ACCESSORIES



Underarm Pads 150201

Foam Handgrips 150202

Flexifoot Tip 150205

Crutch Tips 150203  
& Walking Stick Stopper 151102

## Knee Cruiser TKW-12

A Knee Walker is a comfortable, highly portable and manoeuvrable mode of transportation that provides great stability and energy efficiency over a small footprint. Recommended user weight: 130kg



## A more comfortable alternative to crutches

The Knee Walker provides the patient with more mobility, stability and comfort post-operatively when lower limb conditions prevent weight bearing.

Not only does a Knee Walker take less energy to propel on hard, level ground as compared with a walker or crutches, it also improves balance due to its broad base of support.

### Features:

1. Eliminates tripping or falling associated with crutches.
2. Less fatigue due to conserved energy
3. Frees up hands.
4. Prevents atrophy by strengthening proximal muscles in affected leg.
5. Provides stability for those with compromised balance.
6. Improves circulation in affected leg.
7. Partially elevates affected leg for less pain and swelling.
8. Can be used as a bench or foot stool during rest.
9. Folds in seconds for transport or storage (no need to disassemble).

### Knee Walkers are typically used for:

- Fractures of the foot, ankle, heel, or lower leg.
- Lower extremity ulcers/wounds (e.g., diabetic).
- Non-union fractures.
- Leg amputations.
- Ruptured Achilles tendon
- Sprained ankles.
- Bunions.
- Gout.

## Knee Cruiser Heavy Duty

Recommended User Weight: 200kg



## Post-Operative Footwear



### Cam Boots

(Controlled Ankle Motion)  
Provide protection, ankle stability and immobilisation for moderate to severe foot strains and sprains, post-surgery or removal of a cast. Comfortable soft foam with easy adjustment.



### Post-Operative Shoes

To protect foot and bandages post-operatively and provide secure non-slip footing.



### Cast Boots

To protect plaster cast from soil and moisture and provide secure, non-slip footing.



### EvenUp

Simple, fast, easy to apply the EvenUp™ uses a patented innovative design which helps to equalize a patient's limb length and reduce body strain while walking.



## PERFORMANCE, STYLE & COMFORT

The S-ERGO series of Lightweight wheelchairs feature Karma's unique S-Ergo shaped seating system.



The ergonomic 'S' shaped seat helps spread the load and prevents the user slipping down in the chair. The seat and backrest are made from a mesh upholstery that is great for keeping cool on summer days. The S-Ergo seat has been pressure-mapped for optimum shape. In addition the seating system benefits from the unique anti-bacterial technology

built into the upholstery that provides protection against odour, staining and deterioration caused by bacteria, fungus and other microorganisms

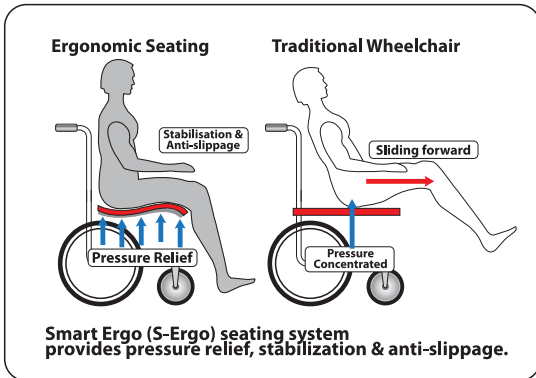

### S-ERGO LITE DELUXE

At 10.3kg the Ergo Lite Deluxe (with Self Propel) is the lightest self-propelling wheelchair in our product range. Equipped with Swing away removable leg rests, double cross braces for strength, durability and quality.



**THIS TOP OF THE RANGE IS ALSO AVAILABLE IN TRANSIT STYLE**

### S-ERGO 125 ▲

The streamline oval tubes not only make the wheelchair look great, but also strengthen the light wheelchair structure.

- Patented 'S' Shaped seating system
- Detachable pads treated with Aegis Microbe Shield
- Outrigged armrests to minimise overall width
- Wider ergonomic arm pads
- Wide footplates with flatter angle
- Swing in/out detachable footrest hangers
- Made from aircraft grade aluminium, frame breaks down to 10 Kg.



### ERGO LITE ▲

The Ergo Lite is a Lightweight aluminium transit wheelchair weighing just 8.7kg complete. The Ergo Lite is equipped with brakes at the pushing handles which can be locked on with a ratchet mechanism. It has detachable footrest hangers and is a great addition to our range of lightweight wheelchairs.

- Made from aircraft grade aluminium.
- The tyres and castors are puncture proof.

## Karma Lightweight Wheelchairs

The multi adjustable ECON 800 is a quality manual wheelchair. The folding aluminium alloy frame is lightweight and functional. The swing-away and detachable footrests can be adjusted to fit your body perfectly. Combine that with its flip back armrest for easy side transfers and you will notice how convenient it is.



*The Karma Econ 800 is available in both Self Propelled and Transit models.*



## Wheelchair Transit

This lightweight transit chair is an economically priced solution. Ideal for trips out and about. Transportation is simple, it has a slung padded backrest that folds down to fit into the car.

Standard Features:

- Aluminium frame (Burgundy) Nett weight 12 kg
- 2 x 12" Rear wheels
- Fold down attendant handles
- User lap belt
- Fixed full length padded armrests , Black nylon upholstery
- 18" (46 cm) seat width
- Detachable swing away footrests
- Maximum user weight capacity: 100 kg



## Premium Lightweight

This Premium Lightweight Self Propelled wheelchair offers full functionality to the user. Its swing away footplates allow for safe patient transfers. It folds easily for storage and transport.

- 18" (46cm) seat width
- 17" (43cm) seat depth
- Half folding backrest
- Net weight 12kg
- Maximum user weight 115kg



# ottobock. Start M2 Series

The Start M2 series is an ideal solution for patients who are sitting in a wheelchair for extended periods of time throughout the day.

A manual lightweight wheelchair, manufactured by Otto Bock, whose name is renowned through the Health industry, and stands for institutional high-quality and technologically outstanding products.

Combined with an excellent quality wheelchair cushion, the Start M2 can be configured to meet the individual postural requirements of the patient, which is very important from an ergonomic viewpoint, particularly if you are sitting in the wheelchair for the majority of the day.

All models of the start series are equipped with antibacterial push handles produced from ProvaMed. The antibacterial effect represents an important property especially in institutional domains for preventing the transfer of bacteria. (no wiping of handles required).

#### **Wheelchair Features Include:**

- Increased weight capacity to 130kg + Crash Tested
- Horizontal Rear Wheel Adjustment on all models
- Patented Quick Depth Adjustment (+/- 1 inch)
- Anti-Bacterial Push Handles (ProvaMed®)
- Improved Cross Brace Clips
- Asymmetric, reversible footplates
- Weight from 14.7kg (Transport weight from 9.6kg)



#### **Available in Three Models: Standard, Adjustable and Configurable.**

##### Seat Widths Available :

Standard	405 /455 /505 mm
Adjustable	380 /405/ 430/ 455/ 480 mm
Configurable	380 /405/ 430/ 455/ 480/ 505 mm

Options:	Side Panel with Height Arm Adjustment
	One Arm drive
	Armrest with swivel unit
	Elevating Footrest
	Amputating leg rest
	Add on Drives (i.e the new support)



**ottobock.**  
*A new generation  
of wheelchairs*



## Breezy® EC Series wheelchairs

The dependable, industry-standard Breezy® EC wheelchairs have your mobility needs covered.

Designed, built and sold with the people using it in mind, Breezy integrate their wheelchair designs around family members, caregivers and suppliers. Thoroughly tested for a safe and stable ride, Breezy is a name you can put your trust in.

### Standard Features

- Swing-away foot plates
- Dual axle allows the seat to be lowered to hemi height
- Chrome-plated, carbon steel frame is built to last.
- Wheels have moulded contours to add strength and durability
- Full size chart pocket
- Industry-compatible front riggings
- Available in the following seat widths.

Seat Width	Weight Capacity
45.72cm (18 Inch)	113.5 kg
50.8cm (20 Inch)	135 kg
55.84cm (22 Inch)	205 kg
60.96cm (24 Inch)	205 kg



## Breezy BasiX 2

This wheelchair represents improved adjustability and rigidity, combined with a modern, clean look. Improvements include greater seat depth adjustment (41cm to 46cm), a tension adjustable backrest which is extendable from 41cm to 46cm and a more robust, rigid castor attachment (0, 3 and 6 degrees). Highly efficient and easy to use. We also hire these wheelchairs in 14 and 16 for Children and 18 Inch for Adults.

### Features and Options:

- Transit model available
- Castor Fork Adjustment
- Axle Plate Adjustment
- Height Adjustable handles
- Elevating Leg Rest
- Rounded Arm Rests
- Available in the following seat widths:

Seat Width	Max. Weight
35.6cm (14 Inch)	125 kg
40.64cm (16 Inch)	125 kg
45.72cm (18 Inch)	125 kg
50.8cm (20 Inch)	125 kg



## ACCESSORIES

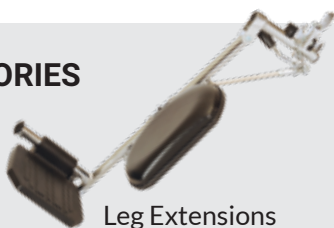

Leg Extensions  
Left - 150808L Right - 150808R



Stump Support  
Left - 15080L Right - 15080R



Seat Belt Assembly  
150913

# Tilt-In-Space Wheelchairs

## Rehab RS Classic Tilt-in-space Wheelchair

The Rehab RS is designed for a user who has limited ability to reposition themselves in a device and as a result, is at risk of pressure injuries.

- Tilt (26°) and backrest recline (30°) facilitates weight re-distribution and the preservation of skin integrity. It also optimises user comfort, decreases user fatigue and assists with head control.
- Adjustable seat depth and width.
- Height adjustable and removable armrests.
- Adjustable headrest.
- Heavy duty, padded, elevating leg rests (std).
- Crash Tested – to AS/NZ3616.196
- Maximum user weight 180kg



## Breezy Relax Tilt-in-space Wheelchair

The Breezy Relax is a multi-function tilt and recline (including anterior tilt) wheelchair with a wide range of features and adjustments.

- Simply adjusted without special tools.
- Comes standard with anatomically shaped seat and backrest
- Adjustable seat height and depth, adjustable height removable armrests with sliding arm pads
- Elevating detachable leg rests with angle adjustable footplates, reclining height adjustable backrest with removable adjustable three part headrest
- Available in transit or self propel models
- Maximum user weight 140kg

## ROHO Medical Products

It's only air, but what we do with it makes a world of difference. There are no greater defences against wounds and disease than those contained in the human body.

But often these defences need an ally. A partner in the healing process. ROHO DRY FLOATATION technology is that partner. The soft, flexible, interconnected air cells that comprise ROHO DRY FLOATATION products are adjustable to provide a customised fit to a client's sitting or lying shape. As an individual's body shape changes, the cushion adjusts to facilitate blood flow.



### Quadro Select Cushion

The QUADTRO SELECT Cushion allows every user to benefit from a customised fit through the simple push of a knob. The revolutionary ISOFLO® Memory Control offers shape fitting capabilities while the user is seated, allowing quick and easy on-demand adjustment to maximise function. With the built-in stability and simplicity of the QUADTRO SELECT Cushion, no longer will you have to sacrifice maximum skin protection to get stability, positioning or convenience.



### The Harmony Cushion

By combining a lightweight and comfortable ROHO® AIR FLOATATION Cushion Overlay with a pre-contoured foam base, encased within a moisture resistant cover, you can maximise abilities, independence and freedom without the worry of adding unnecessary weight to the mobility system.



### The LTV Seat Cushion

The LTV Cushion lets you customise the seat to your specific comfort level. The LTV is made of individual, interconnected air cells that allow air to slowly transfer from chamber to chamber and evenly distribute body weight pressure.



### The Mosaic Cushion

The MOSAIC cushion is especially suited for users who require a cushion for basic level skin protection, support and comfort. Using air floatation technology, the MOSAIC cushion is not only comfortable, but the use of interconnected air cells to distribute forces evenly across the cushion allows it to be used effectively for low risk skin protection.



### Mattress Overlay

Medical mattresses play a critical role in providing the patient with the appropriate comfort and support. Each of ROHO's medical mattresses offer unique features, options and benefits. Therefore, it's very important to consider all the details and relate them to each individual's needs.

## EquaGel Medical Cushions

The Pressure relieving EquaGel Medical Cushion is made from a durable patented column-buckling gel technology. This allows body load spread by providing a reduced amount of contact area while permitting increased air circulation, therefore assisting with the dispelling of heat and moisture. Patients with poor mobility, hydration, nutrition and/or circulation will benefit from EquaGel, gel seat cushions for wheelchairs. Wheelchair Pressure Relief Cushions contribute to patient comfort and overall outcomes. EquaGel seat cushions are not inflatable and therefore they do not require adjustment and/or ongoing maintenance.

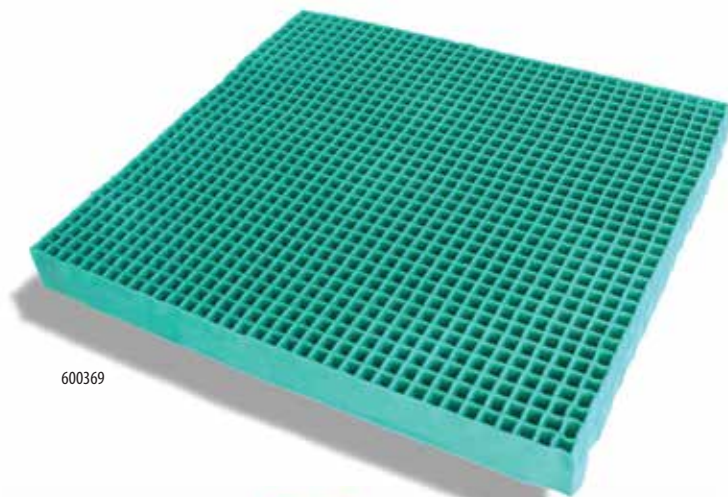

600369

### THE EQUAGEL PROTECTOR

- 100% EquaGel®
- 6.35cm tall EquaGel® in two stages
- Contoured pelvic area of the cushion for additional equalising pressure distribution while maintaining 4.5cm gel below pressure points.

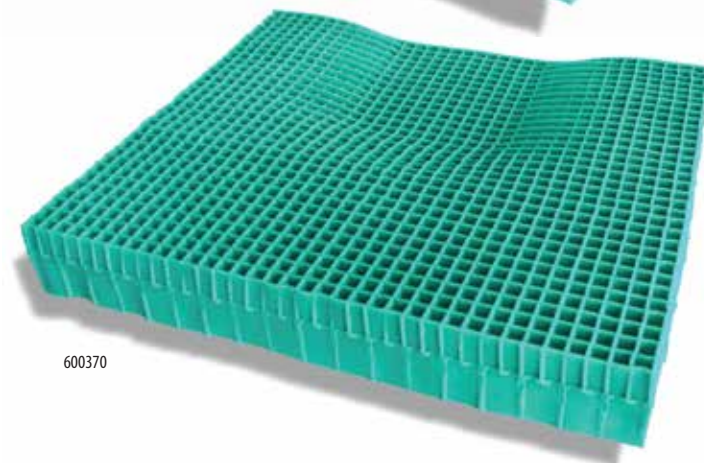

600370

### EQUAGEL GENERAL

- 100% EquaGel®
- 5.08 tall EquaGel® in two stages
- contoured pelvic area of the cushion for additional equalising pressure distribution while maintaining 3.3cm gel below pressure points.

### EQUAGEL ADJUSTABLE

- 100% EquaGel®
- 6.35cm tall EquaGel® in two stages equalising pressure distribution while maintaining 4.5cm gel below pressure points.
- Included are two different pelvic contour inserts that increase the amount of therapeutic gel under the pelvis from 4.45cm to 5cm, 7cm, or 6.35cm deep.

#### All Cushions

- The top layer is thin wall gel and a tight grid for a comfort layer.
- The bottom layer is thicker wall gel and a wider grid for deep posture support.
- Fluid resistant, vapour permeable cover.



600371

**Designed to stabilise the pelvis, protect the skin and position the body, JAY's comprehensive range of wheelchair cushions are lightweight, low maintenance and can accommodate a wide range of mobility seating requirements.**

### **JAY UNION CUSHION**

The JAY® Union™ is a versatile, comfortable, skin protection and positioning cushion composed of a dynamic fluid and foam layering system, moisture resistant inner cover, and an anti-microbial outer cover.

**JAY Flow fluid and memory foam for high performance skin protection and positioning**



60JUNION



### **JAY FUSION™ CUSHION**

The JAY® Fusion™ is an adjustable cushion designed for skin protection that features JAY Flow™ Fluid or ROHO DRY FLOATATION® air insert options in a package that's comfortable, stable and supportive. It incorporates the stability of the J3 cushion with the pressure management of J2.

**Combines the J2's skin protection capabilities with the J3's maximum stability**



60JFUSION



### **JAY J2**

The JAY J2 cushion combines JAY foam, a JAY Flow fluid pad and various cover choices to provide outstanding comfort. The Jay J2 cushion is most suitable for clients who have moderate to aggressive postural needs, and require a high degree of skin protection .



60J24



Spenco® Chair Pad makes any chair, seat or car sitting surface more comfortable.

Spenco® Full Wheelchair Pad protects arms, torso and entire sitting surface.



600202



600204

# Wheelchair Ramps



Rubber Threshold Ramps provide a durable, safe means of navigating uneven household surfaces including small steps and doorways.

A hidden dovetail locking system allows for easy installation and incremental ramp height adjustment of up to 3 inches. Modular design makes Rubber Threshold Ramps a practical and affordable home accessibility solution.



151207 - 1 INCH,  
151208 - 1.5 INCH, 151209 - 2 INCH  
151210 - 2.5 INCH, 151211 - 3 INCH

The Multipurpose ramp is designed to cope with a wider range of obstacles making it more suitable for commercial and travel situations. Longer and wider than the Personal version, yet still very portable. **SWL 300kg.**

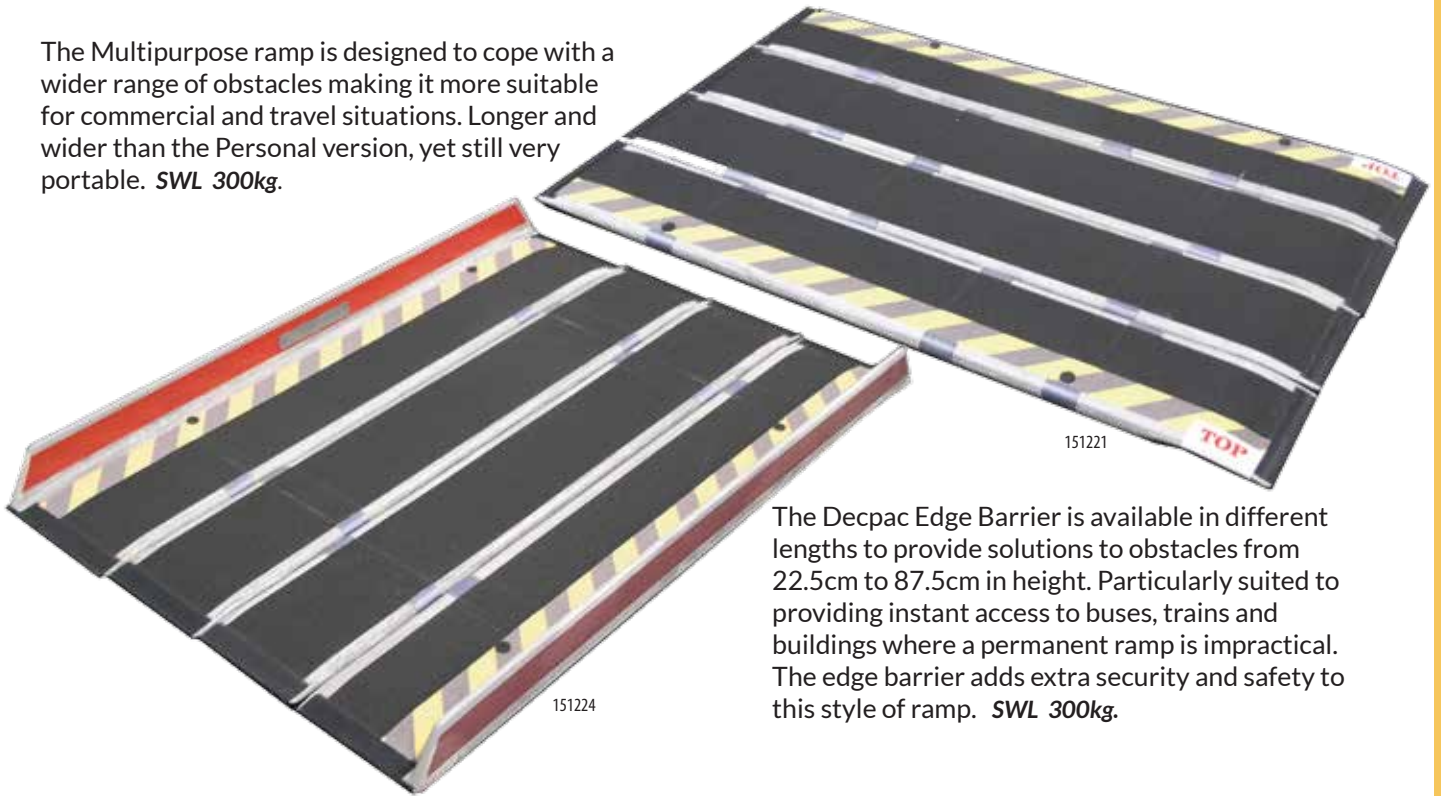

The Decpac Edge Barrier is available in different lengths to provide solutions to obstacles from 22.5cm to 87.5cm in height. Particularly suited to providing instant access to buses, trains and buildings where a permanent ramp is impractical. The edge barrier adds extra security and safety to this style of ramp. **SWL 300kg.**

The Senior Range offers you a flexible variety of ramps to cope with obstacles from 22.5cm to 87.5cm in height. Portable, lightweight and strong. **SWL 300kg.**



### WHAT LENGTH RAMP DO I NEED?

Silver Star single-fold ramps from Pride offer a reliable solution for transitioning curbs, thresholds and other obstacles. They are available in several different lengths. **SWL 227kg.**

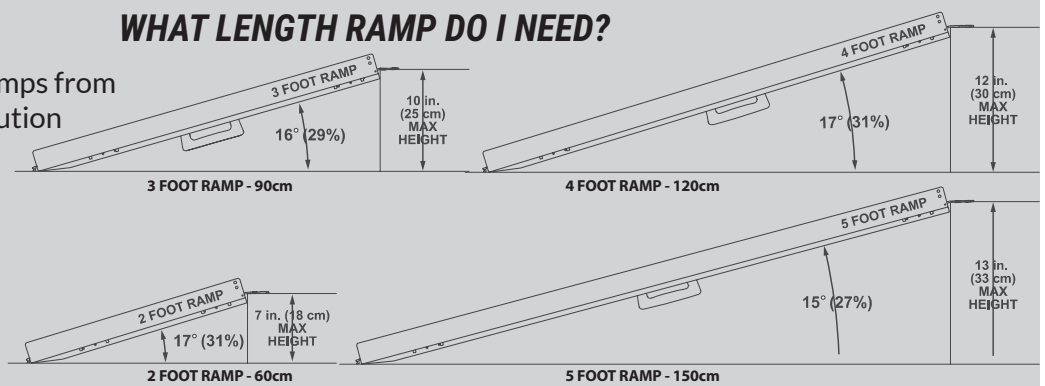

# Folding Scooters

## QUEST 4 WHEEL MOBILITY SCOOTER

**Perfect Compact Travel Scooter.**

- Ideal for Holidaying, Cruise ships, Airlines or Caravanning.
- Unique 3-step folding design.
- Weighs only 25.8kg
- Front & Rear LED lights
- Lightweight lithium ION battery

**Max Weight Capacity: 115kg**

**Max Speed: 6km/h**

**Travel distance on full charge: 20km\*\***



190105



19-0114 LX4

## GO-GO LX with CTS

**The Go-Go® LX is the most advanced travel scooter available.**

- Independent front and rear Comfort-Trac Suspension (CTS)
- CTS offers a new level of performance giving a smooth and responsive ride
- Disassembles into 5 pieces for easy transportation and storage

**Max Weight Capacity 136kg**

**Max Speed 6.4km/h**

**Travel distance on full charge: 16.9km\*\***

## YOGA FOLDING

**Fold and Roll, or store in a suitcase. Ideal for both indoor and outdoor use**

- High ground clearance great for cruises
- Height retractable and angle adjustable tiller
- Strong light-weight aluminium frame designed for easy folding and transporting
- Supplied with a strong sturdy hard case to keep the scooter safe when travelling

**Max weight capacity 114kg**

**Max speed 6kp/h**

**Max distance on full charge 18km**



\*\* Depends on user weight, terrain type, battery charge, battery condition and tyre condition



19-0224





## GO-GO ULTRA X

*The Ultra X has a compact, lightweight design that ensures you always stay independent.*

- Disassembles into 5 easy pieces for convenience
- Available in 3 and 4 wheel model
- Black solid non scuffing tyres
- Lightweight 12amp battery box

**Max Weight Capacity 118kg**

**Max Speed 6km/h**

**Complete with 12amp battery**

**Travel distance on full charge: 12.8km\*\***

**Pride**  
Mobility Products



## The ATTO

*A versatile mobility scooter ideal for use on public transport, including ship and air travel.*

The "ATTO" can be easily parked and folded for transport.

**Assembled Weight 30kg**

**When Split, each half weighs 15kg**

**Maximum Weight capacity 100kg**

**Maximum Speed 6km**

**Travel distance on full charge: 16km\*\***



\*\* Depends on user weight, terrain type, battery charge, battery condition and tyre condition



## PATHRIDER 10

*The sleek and sporty Pathrider 10 delivers high performance operation*

- Low profile puncture proof tyres.
- High intensity LED head light.
- Easy driver tiller with wrap-around handles.
- Durable design.

**Max Weight Capacity 159kg**

**Max Speed 8.5km/h**

**Travel distance on full charge: 21km\*\***

**Pride**  
Mobility Products

# Medium Scooters

## ECO 745

***Stylish eye catching design with attractive modern colour range***

- Loop handlebars offer comfortable finger or thumb throttle operation.
- Adjustable high back contoured seat with simple operation of slide and swivel mechanisms to allow maximum user comfort.
- Removable front basket with carry handle.
- Adjustable power saving LED headlight, indicators front and rear, rear tail lights and reverse warning.

**Max weight capacity 136kg**

**Max speed 10kp/h**

**Max distance on full charge 20km**

 **merits**  
with you for life



19-0220

## VICTORY 10 LX

***The sleek modern design with Comfort-Track Suspension brings a new level of performance & features.***

- With CTS Front and Rear suspension.
- Feather-touch disassembly and standard lighting.

**Max weight capacity 181kg**

**Max speed 9km/h**

**Travel distance on full charge 26km**

 **Pride**<sup>®</sup>  
Mobility Products



19-0103

## FENDE S946

***Stylish new modern design with a modesty panel gives this scooter a smart attractive look.***

- Adjustable suspension front and rear delivers a smooth ride over varied terrain.
- Leather feel contoured high back seat with slide, swivel, recline and adjustable armrests
- Unique battery storage allows for greater floor space and a safe secure lockable storage area for personal items.
- New modern LCD dashboard display offers clearer more easy to read battery gauge, speed, time & temperature.
- Built in speed reduction switch which is activated when turning offering exceptional safety.

**Max weight capacity 150kg**

**Max speed 10kp/h**

**Max distance on full charge 30km**

 **merits**  
with you for life



19-0221

## 745 PLUS

**This new design offers generous foot space & leg room and large battery capacity**

- Loop handlebars offer comfortable finger or thumb throttle operation.
- Adjustable high back contoured seat with simple operation of slide & swivel mechanism to allow maximum user comfort.
- Adjustable power saving LED headlight, front and rear indicators, rear tail and brake lights.
- Built in speed reduction switch, activated when turning, offering exceptional safety.
- 4 Pole motor to supply extra power for climbing hills

**Max Weight Capacity 150kg**

**Max Speed 10km/h**

**Travel Distance 30km**



## Large Scooters



## PATHRIDER 140XL

**Engineered for powerful performance and exceptional style**

- Full suspension and hydraulic sealed brake system
- Lighting package suitable for night time safety
- Deluxe high back seat with pillow top seat
- Suitable for outdoor terrain

**Max Weight Capacity 181kg**

**Max Speed 15km/h (programmable)**

**Travel distance on full charge: 35km\*\***



## Karma KP-25.2

**The KP-25.2 is a foldable electric wheelchair making transport convenient.**

- Built-in multi-functional controller.
- Flip-back and height adjustable armrests.
- Fire retardant upholstery.
- Seat Dimensions 46cm x 46cm (18"x18"),
- Seat Height 50cm

**Max Weight Capacity 135kg**

**Max Speed 10km/h**

**Travel Distance 30km**



# Power Chairs



190103

## GO CHAIR

*The first travel chair that is super portable, manoeuvrability and style at a low cost.*

- Conveniently disassembles into 5 pieces
- Compact design for tight turning radius
- Indoor and smooth surface use only

**Max Weight Capacity 113kg**

**Max Speed 5.65km/h**

**Travel distance on full charge: 12.87km\*\***



190116

## JAZZY SELECT ELITE

*The Jazzy Select Elite delivers a reliable blend of power, performance and style*

- Deluxe high back seat with headrest.
- Excellent manoeuvrability in tight spaces
- Solid puncture proof tyres
- Flip up and fully adjustable armrests

**Max Weight Capacity 136kg**

**Max Speed 6.44km/h**

**Travel distance on full charge: 21.97km\*\***



19-0226

## FOLD & GO POWER WHEELCHAIR

*Folds in one easy step, lightweight.*

- Allows manoeuvrability in tight spaces.
- Adjustable footplate and backrest.

**Max weight capacity 114kg**

**Max Speed 4.7kph**

**Travel distance on full charge 11km\*\***

## Scooter Accessories



190211



190214



190204



19-0206



190202

# Shower Stools & Chairs

## Myco Swivel Shower Chair



The Myco can swivel through 360° and locks at 90° intervals.  
**Seat width:** 445mm  
**Maxi. User Weight :** 160kg

## Heavy Duty Shower Stool & Shower Chair



**Height adj. seat** 46 cm - 59 cm  
**Width between arms** (at seat height): 46 cm  
**Width between arms** (at armrest height) 54 cm  
**Max. user weight capacity:** 160 kg

**Height adj. seat** 44 cm - 57 cm  
**Width between arms** (at seat height): 46 cm  
**Width between arms** (at armrest height) 53 cm  
**Max. user weight capacity:** 160 kg

## Eco Shower Chair w/Arms



Waterproof height adjustable chair with arms for ease of use.

**Seat Height :** 780-900mm  
**Overall Width :** 530mm  
**Overall Depth :** 515mm  
**Width between Arms:** 505mm  
**Seat Width:** 440mm  
**Seat Depth:** 405mm  
**Backrest Height:** 350mm  
**Safe working load:** 125kg

## KCare Shower Stool with or without Arms



**Max User Weight:** 160kg  
**Width Between Arms:** 53cm  
**Width Of Seat:** 46cm

The arms provide assistance on and off the seat.

**Seat Width :** 350mm  
**Seat Depth :** 300mm  
**Max User Weight :** 110kg  
**Depth Overall :** 42-45cm  
**Adj. Height:** 490-610mm



## Eco Shower Stool

Fitted with arms it provides user with assistance on and off the seat.

**Overall Width :** 510mm  
**Overall Depth :** 410mm  
**Width Between Arms:** 450mm  
**Stool Weight:** 3.2kg  
**Height Adjustable:** 490-610mm  
**Maximum User Weight:** 110kg

*It is important to have a stable seat during personal care activities to avoid injuries or falls. The design of our range assists with patient transfer, ensuring safety and confidence.*

# Etac Shower Stools



Etac offers a shower stool for every need - triangular, round or rectangular. They are height-adjustable, comfortable and fit perfectly in every bathroom.



9981801010

### Etac Edge

Fits perfectly in the shower corner and can also be used as a saddle seat, relieving the strain on an aching hip.

- Total width:** 52 cm
- Seat width:** base max 45 cm
- Seat height :** 42-57 cm
- Weight Limit:** 130kg
- Also available:** Low Seat Height Model 34.5-42cm



9981901010

### Etac Easy

Easy to use, easy to move, a round seat is always in the right position.

- Seat width:** 40 cm dia.
- Seat height :** 49.5-53.5 cm.
- Weight Limit:** 150 kg



9981951010

### Etac Smart

Just as comfortable when sitting on the longer side as well as on the shorter side.

- Seat width:** 43 cm
- Seat height :** 42-57 cm.
- Weight Limit:** 150 kg



9981901050

Available for EASY and SMART.

9981801132

Available for EASY, EDGE and SMART.



### Etac Swift shower stool/chair

Swift is a prize-winning series of shower stools/chairs designed with functionality and simplicity in mind. The basic shower stool can easily be transformed to a complete shower chair, depending on the user's needs.

#### Stable on any floor

Swift has a unique construction that adapts to uneven floors thanks to the flexible seat. The soft high quality ferrules adapt to the floor and ensures a good grip. All these features contribute to the users safety.

#### Changes with the circumstances

Swift is adaptable to different needs. It is possible to start using the shower stool, and add arm supports and back support as the user's needs change.

- Seat height:** 42-57 cm
- Seat area:** 54x41 cm
- Total width, with armrests:** 54 cm
- Sitting Weight Limit:** 130kg



#### KEY FEATURES

- Sturdy plastic and aluminium design
- Anti-slip seat pattern for maximum patient safety and stability
- Soft seat pads available as optional accessory

**Bath Tub Transfer Bench**

Designed to provide a stable seat over the bath when bathing. Plastic seat and backrest provides a non-slip surface with holes for water drainage. Backrest and handle adjust to suit left or right facing baths without using tools. Built-in soap dish and hand-held shower slot for user convenience. Also available in a padded model.



100401

- Height adjustable seat: 43 cm - 56 cm
- Seat dimension: W 66 cm D 37 cm
- Max. user weight : 136 kg



100501

**Myco Swivel Bather**

The user sits on the seat from the side of the bath and then swivels over the bath for a wash or shower. The comfortable seat provides back and arm support and is ideal for people who feel insecure on a bath board.

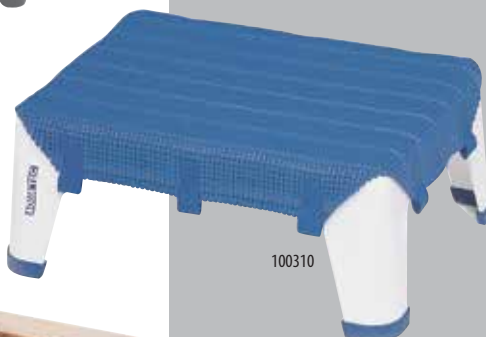

100310

**Aquatec Bath Step**

The Aquatec Bath Step has a unique non-slip, removable, machine-washable cover to easily clean it while keeping your home hygienic.



**Wooden Bath Board**

100301



**Plastic Bath Board**

100302



100601

**Bathtub Grab Rail**



**Deluxe Hand Shower**  
(Single & Double)



100808 100809

**Economy Hand Shower**  
(Single & Double)



100510

**TRANSFER DISK**  
(optional accessory)

**Aquatec Orca Bath Lift**

*Enjoy a long soak and the therapeutic effects of a warm bath.*

The Orca is a battery powered bath seat that will lower and raise you in your tub. An emphasis on ergonomic design allows the Orca to sit lower and further towards the back of the bath, giving increased leg room for deeper and more relaxed bathing. The increased height of the backrest provides full support whilst upright or reclined. An ergonomic floating hand control contains the lightweight battery.

# Shower Accessories



**Chrome Hand Shower and Switchcock.** Designed for the shower as a permanent fixture.



## Wall Mounted, Stainless Steel Grab Rails

25mm & 32mm Highly polished or white powder coated with a flange (Available in 300mm, 450mm, 600mm, 750mm, 900mm)

## Suction Grab Rail

Offers a quick and easy non-permanent solution for more support when bathing or showering. Features suction indicators to show when the handle has been mounted properly and safely.

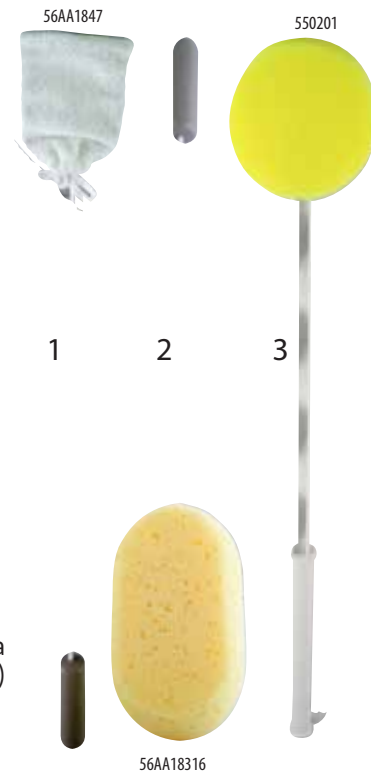

1. Long Handled Toe Washer  
2 & 3. Long Handled Sponges

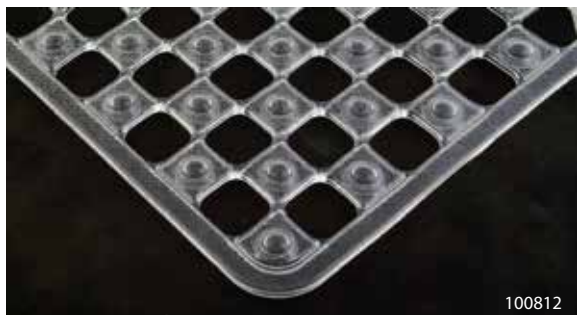

## Bath and Shower Mat

The rubber mat is non-slippery and mildew-resistant for the shower and bath.



## Avivo Shower Sandal

Designed to clean the entire foot without any bending or stretching.

## Lotion & Cream Applicators



The applicator applies lotion smoothly and evenly, the extra long handle is perfect for hard to reach places.



## LimbO Cast & Bandage Protectors

The LimbO is designed to protect plaster casts and wound dressings from getting wet during bathing, it can also be used for swimming and hydrotherapy.



Removable applicator which can be filled with desired cream or lotion.



Over Toilet Seats provide a safe and stable raised seat to assist in toilet transfers. Ideal for those who require greater seat height. Frame is height adjustable to suit individual user requirements.



### Heavy Duty

12-0101W

Height adjustable seat : 45-57 cm  
 Width between arms:(at seat) 48 cm  
 Width at top of armrest : 55 cm  
 Max. user weight capacity 160 kg



### Eco Over Toilet Seat Specifications:

- Seat Width: 370mm
- Width Between the Arms: 450mm
- Height Adjustable: 440mm - 590mm
- Maximum User Weight: 125kg

### Toilet Surround Bar

This sturdy Steel Frame surrounds the toilet to assist in transferring. An alternative to a permanent fixture in the bathroom.

Width between armrests: 50 cm  
 Maximum user weight: 114 kg



120501

### Folding Over Toilet Seat

Designed for travellers and for convenient storage.

Seat Frame width: 445mm  
 Seat Depth: 420mm  
 Adj. Seat Height: 480 - 620mm  
 Max. User Weight: 110kg

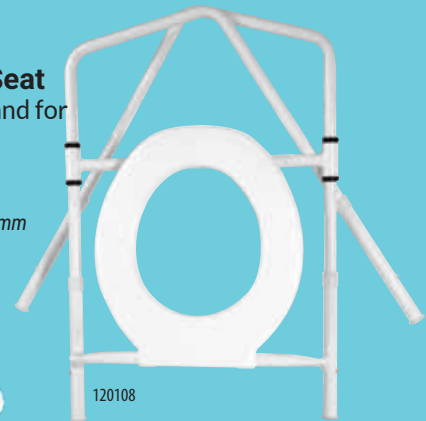

120108

### Fixed Safety Arms

The aluminum frame is designed to fix to the back of the toilet suite using the existing toilet seat fittings, providing armrest supports when transferring on and off the toilet.

Width between armrests: 42 - 52 cm  
 Maximum user weight: 110 kg



12-0603

### Dynamic Heavy Duty Complete.

Over Toilet frame, with splash guard, Pan and Lid

Height adjustable seat: 45-57cm  
 Width between arms @ seat: 48cm  
 Width between arms @ armrest: 55cm  
 Max. Weight Capacity: 160kg Standard

### Accessories



Splash Guard

120602



Pan

120601

# Raised Toilet Seats

Lightweight, all plastic construction for strength and durability. Secured to the toilet bowl with two L-shaped moulded plastic brackets and a front lip, making it easy to fit and remove.

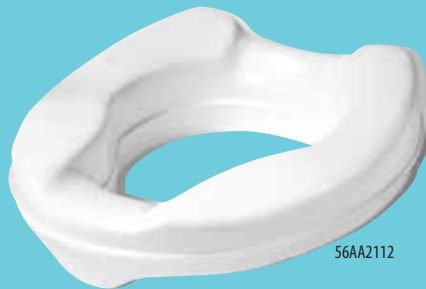

Savanah 5cm (2")



Savanah 10cm (4")



Savanah with Lid

56AA2112L



Savanah 15cm (6")



**Raised Toilet Seat with Arms**

Designed to assist users to lower onto and rise from toilet by increasing toilet seat height. Max. user weight capacity: 120 kg Comes in 5cm, 10cm and 15cm heights.

All Savanah models available with or without lid

## Bedpans & Urinals

**1/ Bed Pan Auto Plas** This general purpose bed pan is made from plastic and has moulded indents for easy transportation. It is easy to clean using steam, water or chemicals.

**2/ Bed Pan Slipper** High quality Bed pan with low profile make it easy and comfortable to use.

**3/ Spill proof Urinal** This urinal has a specially designed spout that prevents spilling and leaking.

**4/ Economy Urinal with Lid** Comes with lid, handle, and graduations for liquid measurements.

**5/ Female Urinal** The sculpted opening helps to ensure a close fit against the body and eliminate leaks.

**6/ Urinal Holder** Hangs off the edge of the bed, within easy reach of the patient.

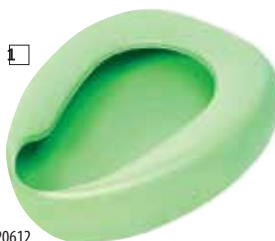

120612

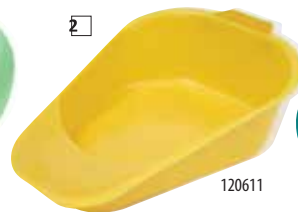

120611

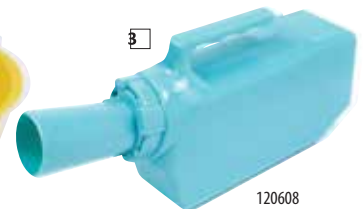

120608



120607



120609

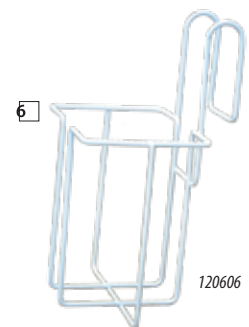

120606

## Bottom Wipers

These bottom wipers have a moulded plastic head with recessed serrations to grip the paper. Mounted on a lightweight curved handle they are designed to be used from the front. The paper is easily removed after use.



**Buckingham Easy Wipe**  
Research led ergonomic shape helps those with limited manual dexterity.

56AA2651



**Bottom Wiper Standard**

56AA2650



**Folding Wiper**  
Ergonomic design folds into three for easier storage.

56AA2652

**A three in one product with many smart functions.**

*"Everyone should be able to live a free & independent life and pursue their dreams regardless of any physical circumstances".*



### **Comfortable and functional**

Swift Commode is discreet and comfortable. It can be set with a slight forward tilt to facilitate sitting down and standing up. The integrated pan has a tightly securable lid that locks automatically when lifted. Swift commode is supplied complete with soft seat pads.

### **Easy cleaning**

With smooth surfaces and removable padding, the Swift commode has been designed to enable easy cleaning. Its light weight pan and the integrated handle make it easy to transport and clean.

### **Easy handling**

Swift Commode comes flat packed and is easy to assemble and height adjust, without using tools. The legs can be removed for transport. *With removable padding, the Swift commode has a discrete design and is also comfortable for dressing and undressing.*

Total width: 56 cm (22")  
Seat width: 54 cm (21¼")  
Seat height min-max. 42-57 cm (16½-22½")  
Width between the armrests: 45 cm (17¾")  
Weight: 5.4 kg (12 lbs)  
Max user weight: 130 kg (287 lbs)



9981702030



*The pan with lid is integrated in the seat surface.*

**etac**<sup>®</sup>

Creating Possibilities

# Commode Chairs & Transporters

Commode chairs are designed to sit in the bed room. They reduce the distance to the toilet from the bed, minimising the possibility of a fall. Our range of bedside commode chairs are comfortable and easy to clean. Their discreet and stylish design can blend into any style of room without looking out of place.



**Economy Commode**

120201

Economy  
 To top of seat 48-60cm  
 Width between Arms 45cm  
 Width Overall 58cm  
 Sitting Weight Limit 110kg



**Dynamic Commode Chair - Deluxe**

120202

Deluxe  
 To top of seat 53-65cm  
 Width between Arms 63cm  
 Width Overall 61cm  
 Sitting Weight Limit 110kg



**Medpro Commode**

120204

Medpro  
 To top of seat 40-55cm  
 Width between Arms 45.7cm  
 Width Overall 51cm  
 Sitting Weight Limit 136kg

## Transporter Commode Chair

This versatile range of Transporter Commode chairs are designed to reduce transferring and ensure patient safety. They combine durability and practicality, enabling the range to be integrated into the care environment.

- Stainless Steel Frame
- The safety swing back armrests are fully rotational and removable
- Stainless steel pan rack guides.
- 125mm stainless steel castors.
- Sliding one piece Platform or swing-away footplates
- Available in attendant or self propelled, in 460mm or 600mm seat widths
- Australian Standards approved. (150kg)



120341

Attendant propelled Platform



120342

Attendant Footplate



120347

Self propelled Footplate



120344

**Tilt-in-Space Commode**

- Backrest recline angle of 15, 20 and 25 degrees.
- Backrest folds down to reduce storage space.
- Adjustable swing away pivoting footplates.
- Australian Standards(150kg) approved.



120352

**Seat Cushion \***  
 PU seamless seats offer excellent durability and easy cleaning.



120305

**Seat Cushion \***  
 Soft Seat feature softer foam inners, and are a great solution for those requiring additional pressure relief and comfort.

\*Available in Open or Closed front, and in dimensions to suit all chairs



120346

**Bariatric Transporter**

This heavy duty commode features a reinforced frame and drop down arm rests. Australian Standards (400kg) approved.

## K-care Transporter Commodes

All K-care Transporter Commodes are designed to minimise transferring, and help to safely move patients around the care environment. The shower commode range is durable and long lasting with a stainless steel frame, impervious PVC straps and water resistant castors.

Features Include:

- **Simple-to-use swing-up arms**
- **The back rest has 3 flexible straps for comfort.**
- **An integrated push handle**
- **125 mm castors make the unit easy to manoeuvre.**
- **Seat Dimensions 445 W x 430 D mm**
- **Weight Rated to 160kg**



120306

Adjustable height footplate with swing - away foot rests



120305

Foot operated retractable footplate



120307

Large self - propelling wheels that are flush with the top of the seat to allow unrestricted side transfer



Swing-away elevating leg support, left or right

Right - 120318 Left - 120317

Swing-away padded stump support, left or right

120317L 120318R

Folding safety arms

120327

Padded, clamp-on head rest

120328

## ACCESSORIES



120370

Oxygen Bottle Carrier



120369

Adjustable IV Pole



120612

Pan Auto Plas



120359

Pan Carrier



120364

Leg Rest

# Etac Clean Shower Commodes

*Clean is an award winning best seller. Every detail on the chair is designed for optimal function for both users and carers. Designed to assist users and carers with every day routines.*



**Etac Clean Mobile Shower Commode**

## KEY FEATURES

- Front seat recess; fully open at rear
- Long, removable, swing away arm supports
- Curved footplate with side protection for heels; slides in under seat
- Footplate with full height and tilt adjustment
- 4 lockable castors
- Large range of available accessories
- Available in 49cm and 55cm heights
- Easy, tool-less height adjustment
- Weight rating 130kg

## Accessories



**Clean Soft Back Pad**  
Heat-reflecting soft back pad.



**Clean Comfort Pad**  
A comfortable, hygienic seat pad which makes the hole a little smaller.



**Clean Soft Seat Pad**  
Heat-reflecting soft seat with good anti-slip properties even when wet



**Clean Comfort Kit**



**Etac Clean Height Adjustable Mobile Shower Commode**

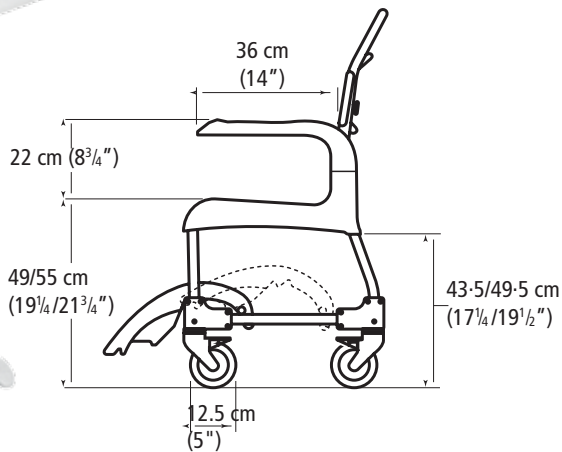

## ACCESSORIES INCLUDE:

- Chest Harness Belt
- Cross Bar
- Positioning Belt
- Splash Guard
- Pan and Lid with handle
- Anti-Tip

**With height adjustment for optimal transfer height and perfect fit over toilets.**

Height range from 475mm to 600mm in 25mm increments



**Pan with lid & Handle**

SWL 225 kg



150406

### Mighty Mack Heavy Duty

Solid wheels provide security and support. storage and transport.

SWL 400 kg



120346

### 60 cm Platform Commode

This heavy duty commode features a reinforced frame and drop down arm rests. It is available in an attendant propelled version only.

SWL 204 kg



150839

### Heavy Duty Wheelchair

55cm seat width User Weight 204kg  
61cm seat width User Weight 204kg  
66cm seat width User Weight 204kg

SWL 227kg



150406

### Bariatric Walking Frame

Approximate user height: 5' 5" - 6' 8"  
Standing width between frame: 62 cm  
Overall maximum width: 72 cm

SWL 210kg



120104

### Bariatric Over Toilet Seat

Height to top of seat: 43 cm-55 cm  
Width between arms (Seat height 58 cm)  
Armrest height: 60 cm. O'all width: 66 cm

SWL 210kg



100111

### Bariatric Shower Stool

Height to top of seat: 43 cm-55 cm  
Width between arms (Seat height 58 cm)  
Armrest height: 60 cm. O'all width: 66 cm

SWL 227kg



150117

### Bariatric Crutches

Available in 2 sizes  
Adult - approx. user height 5' 2" - 5' 10"  
Tall Adult - approx. user height 5' 10"-6' 6"

SWL 210kg



110126

### Bariatric President Chair

Seat width - 55cm  
Seat height - 40-62cm  
User weight - 210kg

SWL 350kg



110104

### Bariatric Kingston Chair

Seat width 55cm - 350kg  
Seat width 65cm - 400kg  
Seat height: 46 cm - 59 cm  
Armrest Height: 65 cm - 78 cm



150101



150403K



150751



### Yellow 5150 Paediatric Walker

Strong, durable and height adjustable with front castors and rear skis.  
 Height: 66 cm - 76 cm ( 25 mm increments )  
 Maximum user weight capacity: 70 kg

### The Nimbo Walker

Sturdy, lightweight aluminium frame, tool free height adjustment to suit various users.  
 Total weight of frame 4kg  
 User weight capacity 34kg

### Forearm Crutches

Crutches specially designed for children.  
 User age: 6 - 10yrs. 121cm (4' 3") - 152cm (5' 0").  
 Maximum user weight capacity: 100 kg



151221

### General Purpose Ramp

Suitable for negotiating steps or any changes in level paths. Also ideal for kids in wheelchairs or on walkers to ascend or descend from vehicles.



### Breezy Wheelchair

35cm (14") & 40cm (16") wheels available.

150857(14) and 150857(16)



150750

### Trotter Mobility Chair

Lightweight folding frame with strap that holds the chair shut when folded. Crash tested for transit. Adjustable set angle, back angle and footrests.  
 Total weight of frame 8.6kg  
 User weight capacity 34kg



### The Diffuser Cushion

Made from premium Memory foam together with traditional foam, this is a great cushion to be used in Wheelchairs or as a multi-purpose cushion. Available specifically for paediatric use 14" X 16".



MADE IN GERMANY FOR OVER 100 YEARS  
DEDICATED TO DIGNIFIED CARE.

VÖLKER

## Healthcare Beds



The perfect combination of  
choice, style and functionality.

*Increasing feelings of independence is a crucial way of helping people regain their dignity and self-esteem which is why every element of the Völker range has been designed to ensure ease of use and provide a sense of security.*

By successfully combining form and function, Völker Healthcare beds can provide increased patient comfort while enabling caregivers to work safely and efficiently.

The unique Healthcare Design from Völker ensures that all beds fulfil their medical purpose while creating a home-like atmosphere that encourages patient wellbeing and recovery



*Völker Healthcare Beds are available in a range of designs and colours.*

# Designed for a home environment



## 5384 Kepler Low Height Bed

Increasing safety by minimising the risk of falls:



*The ergonomic design of the low-height bed combines light weight, high stability and a safe working load of 230kg.*

The 5384 Kepler provides maximum protection for residents who have an increased risk of falling out of bed.

Falls can lead to loss of independence, as well as having other negative implications in the care environment.

This versatile low-height bed can be lowered to 23cm\* and raised to a stable working height of up to 80cm\* to ensure a safe and ergonomic working position for caregivers.

The bed's close proximity to the floor when at its lowest position can give residents who are prone to falls, a greater feeling of safety and may also reduce the occurrence and severity of falls.

Double Castor's increase maneuverability and provide automatic braking for enhanced safety when the bed is in its lowest position.

*Available with the following lying surface sizes:*

*Single – 90cm x 200cm*

*\*Dependent on the configuration chosen*



*The under-bed light improves orientation at night. Controlled using the hand control unit (optional).*

*Designed for a home environment*



## 3080 Health Care Bed

Dignified care through increased mobility.

The Völker 3080 boasts a stylish design and the hidden retractable wheels and choice of colours means it looks great in the home, as well as in professional care environments.

This is a high quality, robustly built and precision engineered bed that will stand the test of time. It's fully height-adjustable making life easier for both users and carers. While the four-section profiling MIS® lying surface ensures users can make themselves comfortable whether sitting up or lying.

The bed can also be easily and quickly converted into a comfort chair position and the convenient handset means the user can be fully in control of all bed functions.

Another key feature is the unique handset controlled electric action locking castors.

The lying surface height can be adjusted from 40 cm to 80 cm ensuring a safe and ergonomic working position for caregivers and provision for easy and safe patient transferring.



*Available with the following lying surface sizes:  
Single - 90cm x 200cm  
Euro King Single - 100cm x 210cm*

# Exclusive Features

## *The Völker siderail patented system.*



The patented Völker siderail system is characterised by its exceptional versatility. It consists of separate elements that are split on both sides that move with the bed as its profile is adjusted. The rails can be adjusted to either one or two levels to ensure that the patient feels adequately protected from accidentally rolling out of the bed.

The siderails are highly versatile and robust. They can assist patient mobilisation by helping with transfers in and out of bed whilst ensuring users don't feel trapped.



## *Völker beds offer the following positions:*

### **\* ELECTRIC HI/LO**

*Flat Positioning - The lying surface can be adjusted on the 3080 Model from 40cm to 80cm.  
The 5384 Kepler Model can be adjusted from 25cm to 80cm.*

### **\* ELECTRIC BACKREST WITH CONTOUR ADJUSTMENT**

*Can be raised up to an angle of 70°(max).*

### **\* ELECTRIC KNEE-BEND WITH LEG LIFT FUNCTION**

*The upper leg section of the lying surface can be raised up to an angle of 45°(max).  
Lower leg section can be moved manually to any position(max 16° angle) by pulling the mattress holder.*

### **\* TRENDELENBURG AND REVERSE TRENDELENBURG POSITION**

*The position can be adjusted up to an angle of 12°.*

### **\* FOOT TILT**

### **\* COMFORT SITTING POSITION**

### **AND FEATURES**

*Safe working load 230kg*

*Built in slide-away safety assist rails.*

*Electric hand control unit.*

*German Made - complies with all European & Australian Standards,  
TGA Listed 10 Year manufacturer's warranty on bed frame and 2 years  
on motors & electrics.*



# VÖLKER

*Fully Maintained and Supported by our  
Australian wide Volker trained Technical team.*

## Comfortable- The Völker MiS® Micro-stimulation System.



The patented Völker MiS Micro-stimulation System is based on neuroscience principles, and detects even minor movements. The lying surface then feeds these tactile stimuli back through the mattress to the resident's body.

This continuous feedback increases body perception and promotes movement and blood circulation in the skin, improving the resident's comfort when sleeping or lying down, increasing mobility and reducing the risk of bed sores.

## Basal Stimulation

***"It's all about the base"*** The Volker Base (MiS ® Micro-stimulation System) assist carers with the concept of Basal Stimulation.



- Supports caregivers in implementing pressure sore prevention.
- Assists carers with the concept of basal stimulation.
- Supports caregivers with pressure management & risk assessment.
- Assists with somatic stimulation, controlling movement sensations relative to effort & weight.
- Promotes increased movement, stimulates the body & helps to reduce pain.
- Maintains restful & comfortable sleeping conditions.
- Helps to alleviate factors that facilitate chronic pressure sores.

"Basal Stimulation is a very comprehensive concept based on a holistic approach to health care. Taking patients reactions and preferences into account is expected to reduce stress, help the patient feel at ease, increase social interaction and independence, and give him the opportunity of sensory perception, movement and communication"

(Nydahl, P. 2005, Journal for Anaesthesia and Intensive bed handling, vol. 12, no. 1, pp. 244-245.)

Seven perception-areas are focal points: somatic-, tactile/haptic-, vestibular-, vibration-, oral/olfactory-, auditory- and visual perception. The most common approach is to use elements of Basal Stimulation, depending on the patient's situation. It is precisely the patient and his / her reaction to the Basal Stimulation or other care that is the linchpin of the whole concept: the nurse adapts the care to the patient's individual needs and circumstances. Over and above the concept of individualisation in Basal Stimulation, there are also specific goals:

*That the patient can maintain life and develop the following experiences:*



- *Feel his/hers own life*
- *Feel security and build confidence*
- *Develop his/her own rhythm*
- *Experience the outside world*
- *Maintain and establish personal relationships*
- *Make sense of his/her experiences*
- *Maintain control over his/hers life*
- *Experience autonomy and responsibility*

# Hospital Beds

## The Dynamic Hospital Bed

Our hospital beds offer the very best combination of build quality, functions and features available in a Homecare bed. The additional benefit of the height adjustable function, and many features adds to the safety of both patients and carers. Strong and durable with an exceptional warranty and service commitment, our range represent excellent value for money whether purchased or rented.

### Features include:

- Simple hand control
- Timber frame bed head and base
- Hospital locking castors
- Available in Single & King Single

### Accessories Available:

- Bed Pole
- Side Rails
- Overhead Monkey Bar



**STANDARD** 160101

- 4 section power adjustable bed
- Height power adjustable
- Back rest powered tilt adjustable
- Knee break powdered adjustable
- Central locking castors
- 3 adjustable bed rest positions
- Integrated full length side rails

### SINGLE

Overall Length: 2230mm  
Overall Width: 980mm  
Laying Surface Length: 2010mm  
Laying Surface width : 980mm  
Mattress Platform height: 340mm to 730mm

Mattress Platform height based on a 150mm mattress: 490mm to 880mm

### KING SINGLE

Overall Length: 2100mm w/ext. 2300mm  
Overall Width: 1162mm  
Laying Surface Length: 1900 w/ext. 2100mm  
Laying Surface width : 1050mm  
Mattress Platform height: 340mm to 730mm

Mattress Platform height based on a 150mm mattress: 490mm to 880mm



**DELUXE**  
With Steel Rail 160101S



**DELUXE**  
With Wooden Rail 160101W

# Dynamic Floorline Bed

The Floor-Line bed is specially designed to lower the more vulnerable patient to floor level, thereby negating the need for side rails. The bed was developed with the focus wholly on patients requiring special care and at risk of falling from a bed and sustaining injuries. The ability to lower the mattress platform to the floor lessens the chance of injury when falling: in addition, the mattress platform can be raised making transfers in and out of the bed and nursing care, easy and safe. Also available in King Single

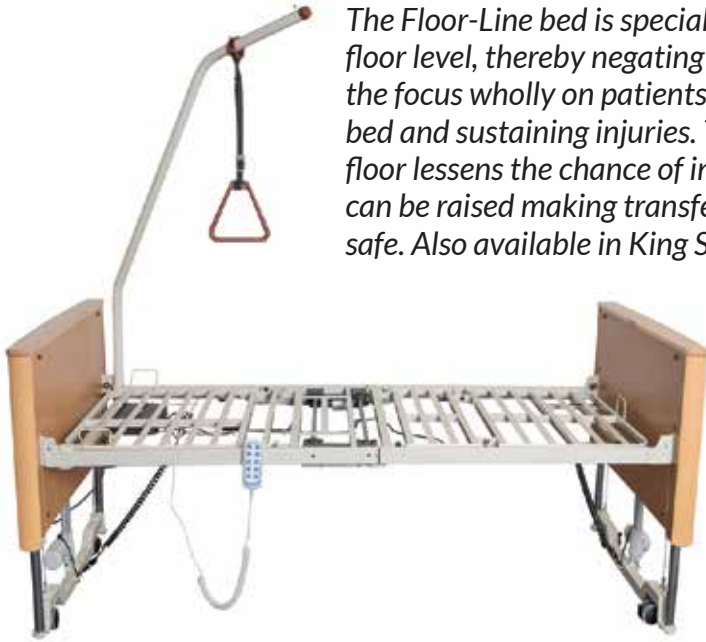

## Single Floorline Bed

Safe working load: 200kg  
Overall length: 2275mm  
Overall width: 1070mm  
Mattress platform height: 75-660mm  
Mattress platform length: 2000mm  
Mattress platform width: 912mm  
Rec. mattress size: 1900 x 880mm  
Backrest angle max: 70°  
Kneebreak angle max: 35°  
Trendelenburg angle max: 12°

## King Single Floorline Bed

Safe working load of 200KG  
External dimensions: 2255 x 1230mm  
Rec. mattress size: 1980 x 1050mm  
Backrest angle max: 70°  
Kneebreak angle max: 35°  
Trendelenburg angle max: 12°

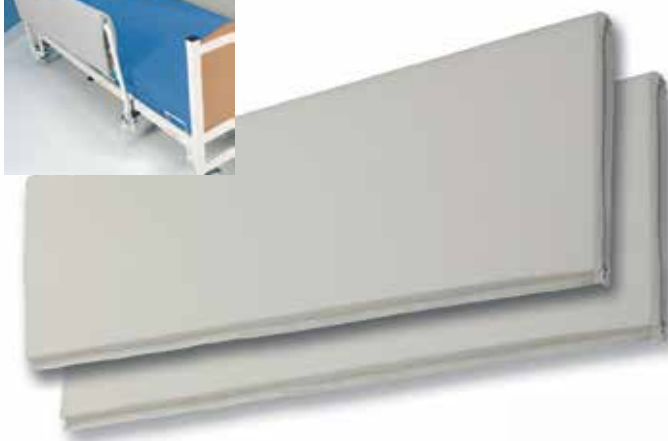

## Padded Bed Rail Protectors

Super soft Bed Rail Protectors are designed to protect patients from injury through limbs striking or getting caught in metal bed rails. Made from soft, medical grade foam cushions covered with a soft two way stretch PU cover including an easy secure Velcro closure for secure attachment. Can be used on both static and collapsible bed rails, the Bed Rail Protectors allow easy access to the bed rail mechanism and can be easily wiped clean.

Available in two sizes – standard (folded height 335mm Length 1260mm Thickness 25mm) and large (folded height 490mm Length 1580mm Thickness 25mm).

## Bedside Safety Crash Mat

Three sections of safety foam covered by a hinged nylon cover are designed to be placed on the ground beside the bed to assist in preventing injuries to patients rolling out of bed. Especially useful with hi-lo beds where nursing protocols prohibit the use of side rails. The Mat can fold up with ties for easy storage when not required.



140601

# The Endless Healthcare Bed

*“End-less”, “en(d)-lsf, <lat.> (infinitem)”*

The bed with endless possibilities

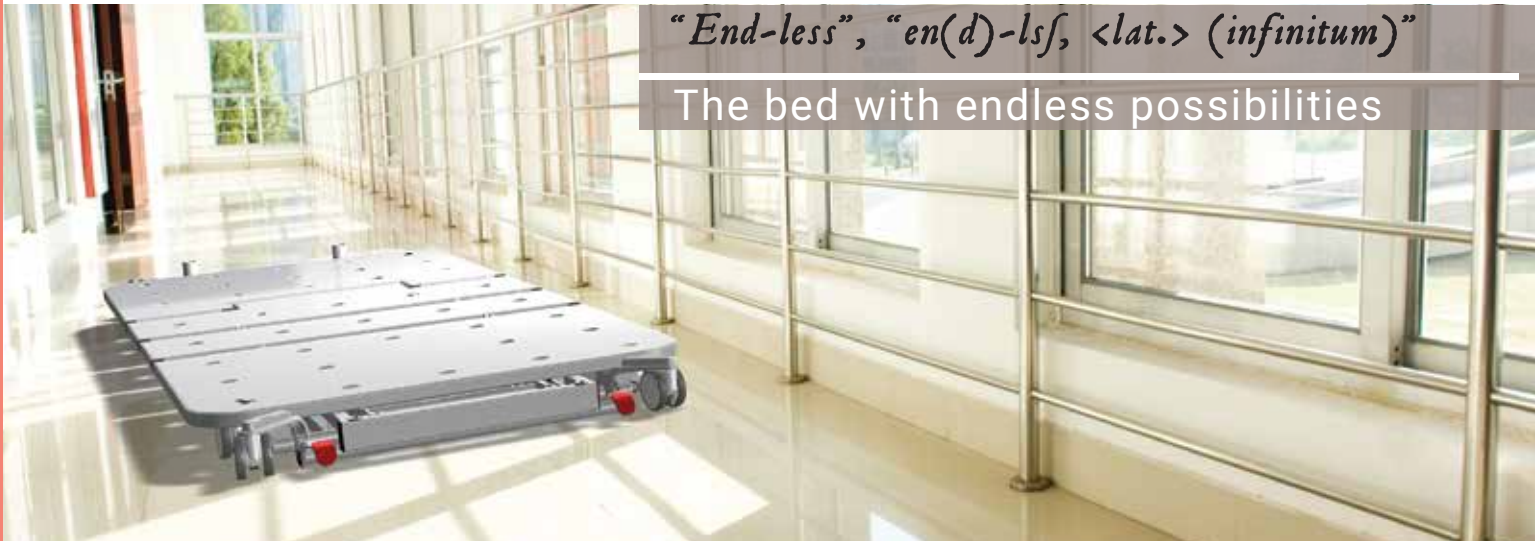

## The only bed of it's type in the world

The universal design of the Endless Floorline Bed is suited for low care, high care and bariatric care. Ideal for patients from domestic through to acute, complex, multifaceted and bariatric settings.

From care of frail, elderly, dementia patients, through to complex, acute, home-care and bariatric settings, this bed has you covered. One bed - endless possibilities

### FEATURES INCLUDE:

- High, medium and low positioning, Backrest and kneebreak function
- Trendelenburg and Reverse trendelenburg
- Chair positioning.
- Dual Locking Castors.
- Auto-regression backrest which reduces shear when profiling.
- Lift off head and footboards.
- 400mm shorter than other floor beds, making it easier to utilise in small and lifts
- Requires no complex installation or maintenance: swift to deploy, easy to maintain
- Is incredibly stable and strong
- Has a genuine\* 10 year frame warranty and 5 year Linak electrical warranty

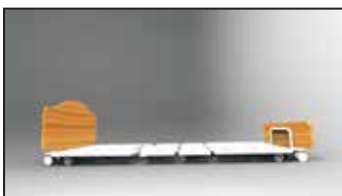

Low Position



Medium Position



Backrest Function



Trendelenburg Position



High Position



Chair Position



Backrest & Kneebreak



Low Position Backrest & Kneebreak

### TECHNICAL SPECIFICATIONS

<u>Low Height for 200kg:</u>	-100mm
	-125mm*(DHHS)
<u>Low Height for 300kg:</u>	-170mm
<u>Max. Height for 200kg</u>	-725mm
	-750mm *(DHHS)
<u>Max. Height for 300kg</u>	-725mm

### ANGLES

Back	62°
Knee	35°
Trendelenburg	15°
Reverse	15°

### UPGRADES

Battery Back Up  
Underbed Light  
Central Locking  
Bolt-on Siderails  
Extension Piece (for extra length)

### OVERALL DIMENSIONS

Single	2080mm x 905mm
Sleeping Surface	2000mm x 890mm
Weight Capacity	200Kg
King Single	2080mm x 1090mm
Sleeping Surface	2000mm x 1070mm
Weight Capacity	200Kg



# The Endless Bariatric Bed

THE ULTIMATE IN  
BARIATRIC CARE WITH  
A 10 YEAR WARRANTY



Designed for the heavier patient. The Endless Bariatric Hospital Bed provides dignity and comfort for patients with a sturdy reinforced frame and 300kg safe working load. Available in various widths to accommodate the patient comfortably, its features include auto regression backrest, backlit handset and underbed light. This ensures the ultimate experience, with safety for both patient and carers. The durable steel bedframe is warranted for ten years, all other components carry a five-year warranty.

## **STANDARD FEATURES**

Electric Hi/Low  
Auto Regression Backrest  
Electric Kneebend  
Adjustable Vascular Support  
Impressive 300kg SWL  
Backlit Handset  
Underbed light  
125mm Braking Castors  
Low Position - 270mm  
High Position - 760mm  
Underbed Clearance 170 mm  
Angles: Back - 65° Knee - 44°

## **OVERALL DIMENSIONS**

2300KS King Single - 2040mm x 1090mm  
2300EW Extra Wide - 2040mm x 1220mm  
2300D Double - 2040mm x 1390mm  
2300 Queen - 2040mm x 1390mm  
2300K King Double - 2040mm x 1820mm

## **SLEEPING SURFACE DIMENSIONS**

2300KS King Single - 2000mm x 1070mm  
2300EW Extra Wide - 2000mm x 1200mm  
2300D Double - 2000mm x 1370mm  
2300 Queen - 2000mm x 1500mm  
2300K King Double - 2000mm x 1800mm

# Static Support Surfaces

**We offer a comprehensive range of static foam pressure relieving mattress' designed to maintain Meriskin integrity and help prevent pressure injury, whilst delivering maximum comfort.**

## **Standard Dual Layer - Low Risk**

The Standard Dual Layer Mattress is an economical low risk foam mattress which is ideal for general use in the home or care environment.

- Dual Core Design
- Inbuilt Convolved upper layer provides excellent comfort and facilitates internal mattress circulation
- Quality base support layer to provide good sleeping posture and comfort
- Quality Pressure Care Cover - 4-Way Stretch Vapour Permeable, Anti-Shear Pressure Care Upper

**Maximum user weight 135kg**

**Single size 1980x880x150**

**King Single size 1980x1050x150**



## **Deluxe Triple Layer - Medium Risk**

The Deluxe Triple Layer Mattress provides even pressure distribution and support for the patient. With profiled hinged strengthened sides the mattress will conform seamlessly to any required bed position.

- Upper Immersion Layer alleviates localised pressure points.
- Mid layer is made of high quality foam providing exceptional comfort and postural support for patient care.
- Firm base layer provides protection against "bottoming out" during transfer and repositioning.
- 4-Way Stretch, Vapour Permeable, Anti-Shear Pressure Care Cover

**Maximum user weight 150kg**

**Single size 1980x880x150**

**King Single size 1980x1050x150**

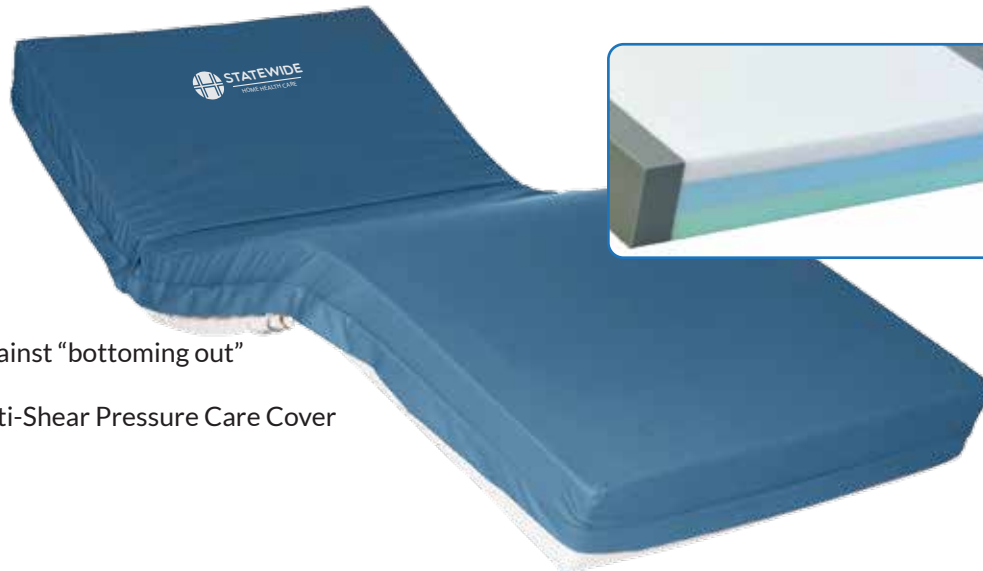

## **The Premium Four Layered Mattress - High Care.**

This is one of the most advanced, high-performance static support surfaces. Delivering effective patient immersion, shear relief, infection control, durability, patient comfort, nursing support and many other benefits.

- Top layer is gel infused visco grade cooling layer works to absorb heat and regulate patient temperature.
- Profiling stabilising sides
- Deep immersion region caters for patients at risk of pressure injury.
- Dual zoned depth provides postural support with open cell foams freely distributing air and enhance circulation.
- Firm base layer for ultimate durability whilst providing additional protection for the sacrum region
- 4-Way Stretch, Vapour Permeable, Anti-Shear Pressure Care Cover

**Maximum user weight 250kg**

**Single size 1980x880x150**

**King Single size 1980x1050x150**



# Pressure Care Air Alternating Mattresses

When choosing a mattress, it is important to consider its effect on skin protection. Pressure care mattresses may be either static or dynamic. In general, a static mattress refers to a mattress that doesn't move when a person lays on it.

A dynamic mattress is powered by a control unit to regularly change the surface beneath a body. A pressure relief mattress is essential equipment for anyone at high risk of developing pressure ulcers or who have existing pressure ulcers.

All our mattresses use alternating pressure. This means that air is pumped into cylinders that are placed parallel to each other inside the mattress. As one set of cylinders inflates, the other set deflates. This way the pressure under any part of the body is relieved on a regular basis. Achieving an exceptionally high standard in pressure management, they operate by a sequence of air cells gently inflating and deflating in accordance with established alternating principles.

## Carilex 5 Overlay

This is an alternating air overlay system that offers a combination of alternating and static features for low to medium risk patients. The Carilex 5 air alternation overlay offers advanced features such as low pressure alert and internal pressure monitoring.

### Features include:

- Intelligent Pressure Sensing Technology
- Low pressure alarm
- Auto-set – no need to input weight, with ability to manually adjust for patient comfort
- Max. User Weight - 250kg



## Carilex 8 Replacement - Low to High Risk

A superior air alternating pressure mattress replacement system. Offering maximum comfort with Intelligent Pressure Sensing Technology (IPS) responding to patient movements by automatically adjusting internal mattress pressure.

## Carilex DualFlex Hybrid Mattress – Low to High Risk

The DualFlex Hybrid mattress is a dynamic replacement mattress system when patient comfort is of utmost priority. The Hybrid combines both high performance static foam, and active alternating air cell technology for exceptional patient comfort and healing. This mattress caters for both higher or lower risk patients all in one, offering a cost effective pressure relieving mattress solution that caters for patients as their needs change.

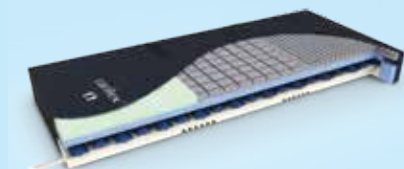

Specifically developed for patients at 'High Risk' of developing pressure ulcers, this high-performance foam layer features a zonal area design, including; GELTEX® inside technology, to provide effective redistribution of pressure on the sacrum, head, shoulder blades and heel areas. Alternating therapy can be quickly and easily applied by connecting the ultra-quiet pump, whilst still providing a peaceful sleeping environment.



### Features include:

- Intelligent Pressure Sensing Technology
- Low pressure alarm
- Auto-set – no need to input weight, with ability to manually adjust for patient comfort
- Max. User Weight - 250kg

# Pressure Care



600203

## Foot Pillow

Spenco® foot pillows provide relief of pressure for the feet, heels and ankles whether in bed or wheelchair. One size fits all with a Velcro closure. (Sold by the pair.)



600307

## Lambswool Heel and Elbow Protectors (Pair)

Sheepskin will relieve pressure, friction and moisture. Wool will provide cushioning as well as air circulation. Ideal for the prevention of pressure sores.



600316

## Lambswool Padded Sleeves for Heel or Elbow (Pair)

Slip on. Medical Sheepskin helps to reduce pressure in heels and elbows to reduce incidences of vulnerable area skin breakdown. Sold as a pair



63A730001

## Elbow/Heel Protectors

Comfortable, stretchable stocking is proportionately knitted for a close fit. The shock absorbing Akton pads included with the protectors will not bottom out. Pad is removable for washing. Available in Small, Medium & Large. Sold as a pair.



600201

## Bed Overlay

Spenco® Bed Pad with Silicore Padding helps to make the bed more comfortable by reducing pressure. Ideal for hospital and domestic use.



*Spenco® Silicore® Padding Products help prevent the development of pressure sores on vulnerable areas of the body.*

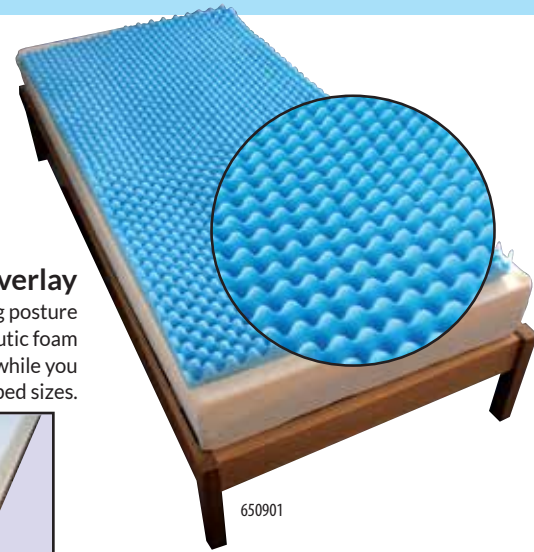

650901

## Dimple Foam Mattress Overlay

Dimples correctly align your sleeping posture and reduce pressure points. Therapeutic foam overlay stimulates and aids circulation while you sleep. Available in all bed sizes.



650906

## Memory Foam Overlay

Memory Mattress Topper disperses pressure and cradles the body in perfect harmony for near-weightless comfort and pressure-free support. Temperature-sensitive Memory Foam conforms to your shape, cushioning load, reducing pressure. Available in all bed sizes.



600302A



600301A

## Medical Sheepskin Products

- Provide a natural solution for problem sleepers.
- Encourage good circulation, helping muscle relaxation and avoiding chills.
- Soothe pain experienced by sufferers of rheumatism, sciatica and backache.
- Give added comfort to those confined to one position for long periods of time.

*Medical Sheepskins and sheepskin underlays encourage good health and can help improve quality of life.*

The Sheer Comfort Foot Care range has been designed to provide comfort, support, security and freedom to those at risk from damage to the skin of the feet or ankles. All products are available in a range of styles, shapes and sizes.



### Wrap-Around Boot

Easy to put on, adjust and take off, the wrap-around boot provides adaptive support and accommodating fit with a low-profile sole allowing outdoor wear.



### Pressure Care Boot

The Pressure Care Boot™ is designed to provide comfort, support and freedom to those at risk from skin ulcers of the foot or ankle, The open toe design allows toe separation and circulation inspection without the need to remove the shoe.



### Short Slipper Boot

The Short Slipper Boot™ is ideal for use both indoors and in bed, and is designed to provide total foot protection.



### Tall Slipper Boot

The Tall Slipper and Pressure Care Boots are designed to provide protection to the entire lower limb in as unencumbered a design as possible. (For use indoors, in bed, or in an inclined chair.)



### Sovereign Snugs

The Sovereign Snug is a low-profile moccasin-style slipper designed to provide exceptional comfort in a pleasing design.



### Heel Protectors

Providing support and security to the delicate heel and ankle area, these flexible protectors can prove invaluable for prevention and rehabilitation of skin ulcers, tears and irritations.

### Elbow Protector

The Sheer Comfort Elbow Protector redistributes pressure and thus eases blood flow over the bony joint. It encourages skin maintenance and repair over this problem area.



# Skin Protection



DermaSavers protect fragile skin from sustaining damage caused by friction, rubbing, abrasion and pressure that could lead to skin breakdown, tears and splits.

DermaSavers can also help to heal existing skin tears, splits and lacerations without the restriction of bandages and dressings.

DermaSaver Skin Protectors are garment-like and can be worn at all times, when required. They can be worn in bed, in wheelchairs and whilst walking, and are available in a full range of pressure-relief and skin-protecting products.

They are fully compatible with topical creams and ointments, and because they are breathable and allow air circulation and constant ventilation, they will protect the skin without the drawbacks of bandages or dressings. The moisture wicking properties of the fabric ensure that the skin remains dry and cool at all times.



## Skin Protectas

The Skin Protecta is an easy-to-wear, moisture transporting anti-friction tube. Preventing skin tears and maintains skin integrity on the limbs of the elderly and those suffering from compromising skin conditions. Consisting of a cushion loop construction made from a highly specialised fibre called Coolmax® which is soft and light, Skin Protecta is fully washable and easy to pull on. Available for the arm or leg.



HipSaver products restore confidence of motion to the elderly, both preserving physical health and increasing senior mobility. HipSaver products are incredibly soft and very comfortable to wear, whilst offering the most effective superior protection.

HipSaver is available in a variety of designs to suit all types of wearer needs, ranging from the elderly in nursing homes, to those who daily participate in exercise programs and even robust activities like jogging.



Hip Measurement	Size
70cm to 81cm (28" to 31")	XS
82cm to 92cm (32" to 35")	S
93cm to 102cm (36" to 39")	M
103cm to 114cm (40" to 44")	L
115cm to 127cm (45" to 50")	XL
128cm to 146cm (51" to 57")	XXL

### Nursing Home *Style*

Designed for the mobility and comfort of residents as well as convenience and peace of mind for caregivers. 90-HSNH

### Slim Fit *Style*

Designed for optimum style and comfort, HipSaver SlimFit looks good, feels good and pulls on just like regular underwear. 90-HSSF

### Tailbone *Style*

Protection for both hips plus tailbone protection for backwards falls. 90-HSTB



### Quick Change Male

The convenience of a snap-down crotch panel allows quick and easy changing of incontinence pads and diapers. 90-HSQC



### Open Bottom

Perfect for those with urge incontinence or challenges in getting clothing on and off. 90-HSOB



Reduce the risk of head and brain injury with HeadSaver

- Lightweight, comfortable head protector;
- Available in a range of styles to suit all adults.

\*Nursing Home, Slim Fit & Quick Change are all available as high compliance (Pads sewn in) with tail bone protection.

# Bed Cradles & Poles

## Bed Cradle

1/ Adjustable Bed Cradle  
Designed to support the bedclothes, thus keeping pressure off your legs and feet.



## Bed Poles

- 2/ 'Cobra' Bed Pole
- 3/ Original Bed Pole (Single / Double)
- 4/ Universal Bed Pole
- 5/ Clamp-on Bed Pole
- 6/ Recurved Bed Pole-square base
- 7/ Clamp-on Bedstick with hook tip

The bed pole is designed to fit under the mattress and provide a firm handle to assist positioning, and getting in and out of the bed.

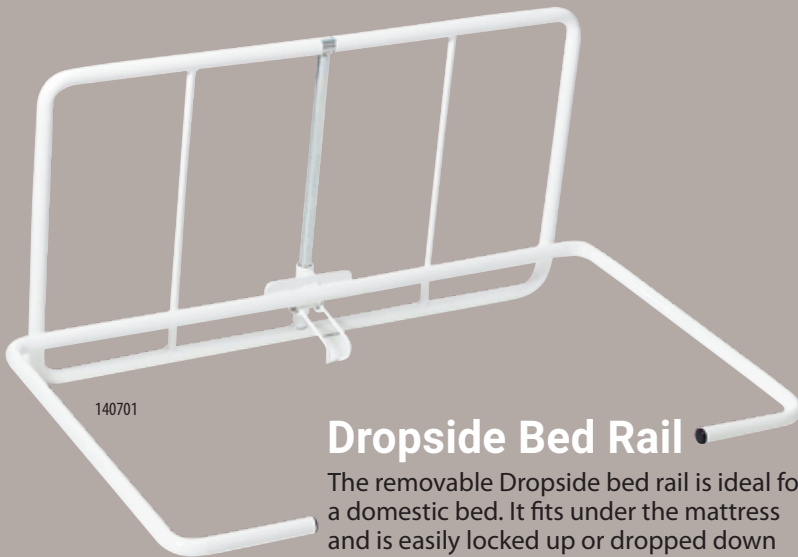
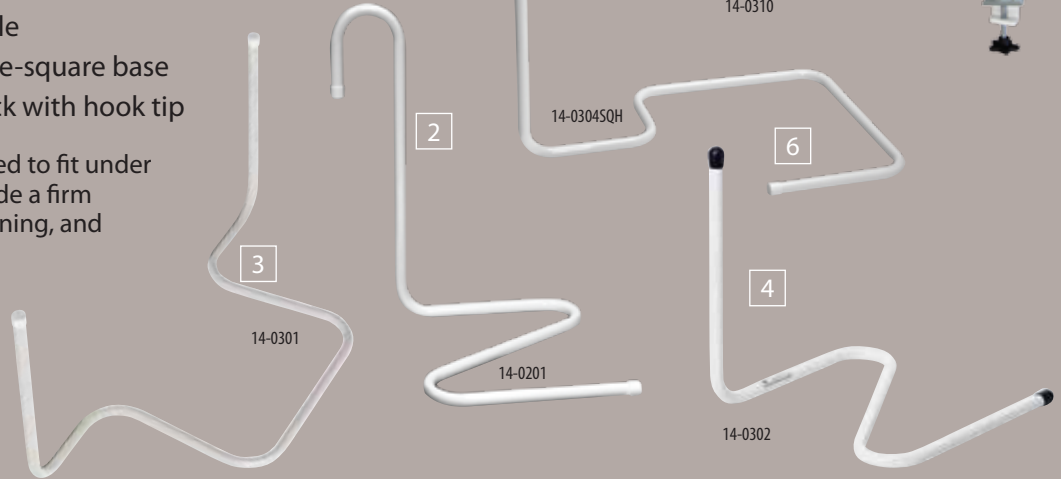

## Dropside Bed Rail

The removable Dropside bed rail is ideal for a domestic bed. It fits under the mattress and is easily locked up or dropped down when required.

Rail length is 900mm

## Overhead Monkey Bar

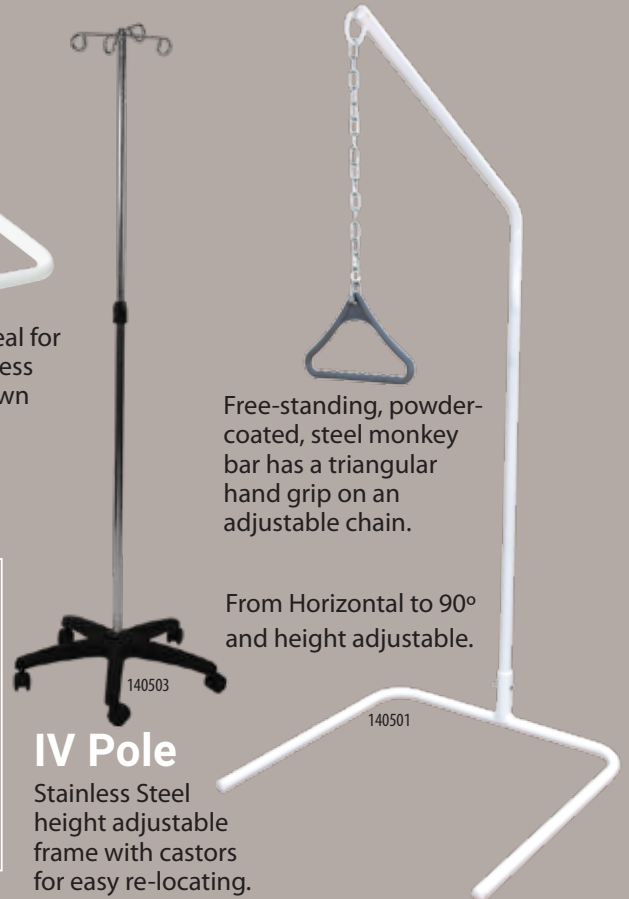

Free-standing, powder-coated, steel monkey bar has a triangular hand grip on an adjustable chain.

From Horizontal to 90° and height adjustable.

## IV Pole

Stainless Steel height adjustable frame with castors for easy re-locating.

## Bed Raiser

- 1/ Bedraisers 2 Inch ST-BR2
- 2/ Bedraisers 4 Inch ST-BR4

Designed to lift the bed or chair. Available in 2" or 4" varieties.





Over bed tables are lightweight, robust and easy to clean. Their height and tilt adjustments makes them helpful to eat meals from a comfortable seat or bed. The tilting function is helpful for reading the newspapers or books.

## Premium Lift Over Bed Table Split Tilt Top Beech Vinyl Laminate



### SPECIFICATIONS

- Safe Working Load: 0 kg (evenly distributed)
- Height Range: 785 mm to 1050 mm
- Base Length: 610 mm (internal)
- Frame: Powder Coated
- Steel Castors: 4 x Ø 50 mm, 2 x Lockable
- Tilt Table Top: 250 x 385 mm (fixed area)
- Tilt Table Top: 560 x 385 mm (tilt area)

140409A



14-0406

## Economy Tilt-Top Bed Table



### SPECIFICATIONS

- Tabletop can be tilted 30 degrees
- Laminated grey top with lip
- Length: 60cm/ Width:
- Height: (adj). 72-108cm
- Clearance req'd 10cm

140401

## Over Armchair Table

### SPECIFICATIONS

- Laminated top
- Max Load: 10kg
- Main Table: 1090mm x 410mm
- Side Table: 200mm x 200mm
- Overall Width: 1310mm
- Height: 750mm - 915mm

## Over Chair Table



### SPECIFICATIONS

- Heavy gauge tubular steel base
- Height: (adj). 60-100cm
- Length: 75cm
- Width: 44cm

140402



### SPECIFICATIONS

- Designed to sit over a chair
- Laminated ceam top
- Height: (adj). 72-85cm
- Length: 95cm
- Width: 40cm

140405

# Height Adjustable Chairs



## The Kaufman

This fully upholstered support chair is designed with a sculptured backrest for maximum support and comfort.

Seat Height	49-62cm	Width between Arms	46cm
Seat Depth	46cm	Overall Width	63cm
Weight	15kgs	Max. User Weight	160kg



## The Kingston

A low-back bridge chair with a curved back which is positioned to provide excellent posture and control.

Seat Height	46-69cm	Width between Arms	48cm
Seat Depth	45cm	Overall Width	60cm
Weight	15kgs	Max. User Weight	350kg



## The Revolution Chair

The Revolution chair incorporates a unique, patented "swivel-slide" technology, allowing easy access to the chair and to a table edge without moving its legs.

Seat Height	39-51cm	Width between Arms	48.5cm
Seat Depth	48cm	Overall Width	50.5cm
Weight	16kgs	Max. User Weight	120kg

Available also in height adjustable model 11-0134A



## The Panama

This fully upholstered support chair is designed to include a built in lower-lumbar support for maximum comfort.

Seat Height	49-62cm	Width between Arms	46cm
Seat Depth	46cm	Overall Width	63cm
Weight	15kgs	Max. User Weight	160kg



## The President

This high-back chair gives outstanding back and neck support.

Seat Height	49-62cm	Width between Arms	55cm
Seat Depth	46cm	Overall Width	74cm
Weight	18kgs	Max. User Weight	160kg



## The Scandia Day Chair

Designed with air cushioned seat for pressure care comfort, the backrest is sculptured for full lumbar and neck support. Covered in easy clean PU cover and powder-coated steel frame, this chair is height adjustable and is recommended for both domestic and institutional use. (Meal tray available as an accessory).

Seat Height	39-51cm	Width between Arms	51cm
Seat Depth	48cm	Overall Width	73cm
Weight	16kgs	Max. User Weight	152kg



## Leg Rest

This height-adjustable leg rest comes in a variety of colours to match your existing furniture.

110201



11-0138

### Dynamic Glide Day Chair

Dining made easy for everyone. Light weight with a simple weight activated gliding action, this dining chair increases independence and reduces injuries. Allows the user or carer to easily roll the chair into the table. Easy clean wood grain finish  
120kg weight capacity



11-0148

### Stella Chair

The Stella Chair is a fully welded aluminium frame giving strength & lightness, comes standard with a realistic wood grain finish.

Stocked in 2 waterproof fabrics

**Overall Height: 83cm**

**Seat Height: 46cm**

**Overall Width: 64cm**

**Seat Width: 50cm**

**Overall Depth: 57cm**

**Seat Depth: 49cm**

**Seat Height: 460mm**

**Seat Width: 400-500mm**

**Seat Depth: 480mm**



11-0142

### Healthcare Chair

Powered lift armchair assists the user in sitting and standing transfers. Single motor action.

Medical grade Dartex upholstery - Anti-microbial & 3 way stretch. Contoured air bladder in the seating surface can be easily inflated and adjusted with integrated hand pump stowed and concealed within chair when not in use. Removable backrest and seat cushion for easy cleaning & maintenance. Leverage grips promote user independence during the sit-to-stand movement.

Comes standard with 100 mm swivel castors for mobility

Large side pocket for convenient storage

**Seat Depth 51cm**

**Seat Width 51cm**

**Backrest Height 61cm**

**Seat to Floor Height 48cm**

**Maximum user weight 140kg**



11-0147

### Mobicline Chair

A Versatile Mobile Recliner with 125mm castors for easy manoeuvrability Slide Out Footrest and 3-Position Recline Action with Optional Meals/Activity Tray.

**Overall Height: 112cm**

**Seat Height: 53cm**

**Overall Width: 69cm**

**Seat Width: 53cm**

**Overall Depth: 78cm**

**Seat Depth: 49cm**

# Air Support Chairs



## Dynamic Air Chair

*Air Cushion seating for pressure care management*

- Folding wings for easy transfer
- Adjustable Backrest and Calf rest (90 degrees - 170 degrees)
- Reclining Seat: Width 50cm Depth 60cm
- Seat Height: 67cm
- Breathable, fire retardant, water proof polyurethane, four way stretch covering
- Three lockable castors and one steering castor
- Includes tray table, headrest, magazine pocket
- Maximum user weight capacity: 125 kg



Meal Tray Attachment

## REGENCY Health Care Chair

- 'Tilt In Space' Seat - (Incorporating Pressure Management MULTICUSH™ Air Cushion System - Gas Assisted.
- Reclining Backrest - (Incorporating Pressure Management MULTICUSH™ Air Cushion System - Gas Assisted.
- 2 Position Swing-Away Headwings.
- 2 Position Fold Down Armrests.
- Deluxe Legrest Including Footplate.
- 175mm Tracking/Braking Casters.
- 180kg Weight Capacity.
- Australian Made.



## Shell Chair

*Comfortable mobile seating solution designed to maximise user access and social interaction within an Aged Care Facility or Healthcare environment.*

- Forward tilt function assists with chair egress and standing transfers
- Backwards tilt functionality assists in pressure redistribution and patient stability during transfers
- Lightweight and manoeuvrable - 12.5" rear wheels with attendant foot brake, 5" front swivel castors
- Safety Lap Belt, attendant Carer Push Handle
- Adjustable Seat Height, Genuine Dartex PU Fabric - An anti-bacterial, fire retardant fabric that is high stretch to help manage pressure injury risk
- Ergonomic Leg Rest - The supportive leg rest automatically raises or lowers as the chair is tilted
- Maximum user weight 135kg

*A range of easy to operate mobile lifters that allow patients to be lifted and transported from the floor, bed or chair with ease and safety.*

## **Dynamic Heavy Duty Lifting Hoist.**

The Dynamic Heavy Duty Lifting Hoist is a heavy duty, fully featured mobile lifter ideal for the majority of common lifting situations across many care settings. Fold down armrests assist with gait training during rehabilitation or for general toileting. Features the advanced Linak® Jumbo Care Diagnostic Control System for intelligent self diagnostic system capabilities. With low lifting height and soft start / stop function, this product has been designed to provide patient and carer with optimum comfort, safety and security. *Maximum user capacity of 320 kg.*



## **Dynamic Standard Lifting Hoist**

The Dynamic Standard Lifting Hoist is lightweight, with low lifting height and soft start / stop function, this product has been designed to provide patient and carer with optimum comfort, safety and security. This ergonomic lifter is constructed with a powder coated aluminium frame for lightweight manoeuvrability and easy wipe-down cleaning.

*Maximum user capacity of 180 kg*



## **Features of the Dynamic lifters**

- Electrically operated 'U' shaped base with wide flanged front legs for enhanced stability and access.
- Hand-held controller with simple push button operation, includes overload, battery charge and service status indicators.
- Rechargeable battery featuring intelligent diagnostic system for battery level, service status and maximum overload.
- Emergency stop and manual emergency lowering device for optimum safety and control.



## Invacare Birdie Compact 150

Designed to fold easily and without the need for tools, the Birdie Compact can be stored or transported comfortably when space is limited. The compact base and large castors manoeuvre smoothly around beds, in bathroom areas and through narrow doorways. The Birdie Compact is ideal for everyday lifting in the home or an aged care facility environment. Compact without compromising on comfort.

Safe Working Load	150kg
Total width closed (external measure)	55cm
Total length	100cm
Total internal width (base closed/open)	46cm/89cm
Lifting range (from sling attach point)	53cm-160cm
Turning radius	170cm
Base height (top of legs)	11.5cm
Total weight (inc. Spreader Bar)	36kg
Weight of heaviest part (base)	16.5kg
Manual emergency lowering	No
Electric emergency lowering	Yes (up and down)
Castors	Dual 100mm
Charging	Internal and External Std

## Invacare RoZe Standup Lifter

The Invacare RoZe Standup Lifter provides assistance to users capable of bearing some degree of their own weight. It can be used to assist transfers from seat to seat or from seat to standing and is easy to operate in confined spaces. The technology built into the RoZe with 'Soft Start' and 'Soft Stop' functions and wide leg openings ensures a smooth and safe transfer. The RoZe is mounted on four wheels and can easily be moved to wherever it is needed.



Overall height	94 cm to - 161 cm
Clearance	12 cm
Castors	10cm
Safe Working Load	200kg
Length of Base	112cm
Base width operation	66cm
Height of Base	12cm
Min height of central suspension point	94cm
Max height of central suspension point	161cm
Machine weight	53kg



a

## a/ General Purpose Sling

Available in four sizes in a choice of fabric or mesh. The General Purpose sling provides easy fitting and good support for patients with some upper body control.

## b/ General Purpose Sling with Head Support

Available in five sizes in a choice of fabric or mesh. The sling provides easy removal of clothing or toilet transfers. Recommended for general toilet transfers for the less secure patient.

## c/ Paediatric Sling

Available in three sizes in mesh only. The sling provides easy fitting and good support for children or small adults. Designed for general lifting with children or small adults.

## d/ Standup Slings

Standup Slings are designed to lift the patient comfortably from a seated position into a relaxed upright position. The high-cut, padded Stand Up Sling supports the patient from waist to shoulder while allowing the arms to move freely so that the hands can reach naturally to grip the support rails as the patient rises.



b



c



d

## Etac SlingOn

Primarily designed for easy insertion of a hoist sling in bed without the need for rolling or moving the patient. The Etac SlingOn is an optimal tool for users that need frequent hoisting.

### Intended Use

- Application of a hoist sling without rolling
- Minimise friction under pressure points
- Turning
- Positioning
- Move higher up in bed



**Etac Sling On**  
LARGE 99-437  
SMALL 99-IM437/5

## Etac 4Way Glide LPL

A complete in bed system for turning and positioning of users with reduced mobility, high weight, pain or pressure issues.

### Intended Use

- In bed system, user with reduced mobility
- In bed system, heavy user or user with pain or pressure ulcer
- Turning
- Positioning
- Support horizontal transfer
- Can be used with support of a hoist



**Etac 4way Glide**  
99IM110200



## Transfer Boards

A transfer board is intended to bridge shorter gaps when performing seated transfers. The board's low friction upper surface allows the user to transfer independently or with assistance.

Transfer boards are used when transferring between bed and wheelchair / shower chair, between wheelchair / chair / toilet chair or to and from the car.



**Etac 3B-Board** 99IM403

A traditional curved transfer board for use in multiple transfer situations.



**Etac E-Board** 99IM408

A light, thin and flexible transfer board designed for easy use; available with or without wings.



**Etac E-Board with wings**

MED 99IM404 60x33cm  
LARGE 99IM405 75x33cm



**Etac Butterfly** 99IM401

Long, wide and stable transfer board with special cut outs for wheelchair positioning. Can be used with the Butterfly GlideWing providing additional low-friction surface for increased slide function.



**Dolphin** 99-IM409

A sturdy and stable transfer board uniquely designed for toilet transfers.

**All Etac Transfer Boards have a non-slip surface on the underside. Combining a transfer board with a glide cushion provides even lower friction and is recommended when the transfer involves bare skin, for instance to and from a shower chair or toilet.**



## Etac MultiGlide Gloves

Versatile for a range of patient handling situations, Etac's MultiGlide Gloves are ideal for small re-positioning adjustments, movements or smoothing out bed sheets. Also useful when checking for adequate support when using pressure relieving cushions or mattresses, the glove facilitates placement of the hands between the user and mattress or cushion.



## Etac Positioning Wedges

Etac Positioning Wedges are a multi-purpose product for use as a standalone positioning device or as an additional stability tool with other products. Ideal as a temporary side bolster to help prevent falls.

### Key Features

- Small and large sizes available
- Comfortably support patient in static position
- Minimises strain on care
- Non-slip cover for easy wipe cleaning

## Slide Assist

The Slide Assist Range encourages "zero lift" or "minimal lift" policies, in domestic and institutional environments. It aims to enable carers to move people with minimal effort, without the risk of injury and discomfort to those being assisted, therefore enabling safe patient handling with comfort and dignity.



Slide Assist products are useful for the correct positioning of people on pressure care cushions, seating the elderly at dining tables, repositioning disabled patients on their wheelchairs after bathing or toileting, or sliding patients in the correct position on their beds.



## Etac Turner

A practical aid which supports and activates the patient when transferring from one seated position to another. It offers security for the person being transferred and will not strain the caregivers' back.

### Easy and safe transfers

- The Turner reduces the risk of falling, and it also allows the caregiver to work in an ergonomically correct position.
- Unique patient turner and transfer aid that facilitates seat to seat transfers, for patients who are able to bear their own weight when standing.
- Allows carers to work ergonomically, without strain to back or arms while still maintaining eye contact.
- Promotes continued mobility as patient actively moves to a standing position.
- Movement up and down controlled by the patient for enhanced security.
- Low footplate (13 mm high) makes foot placement easy while non-slip surface offers additional security.

## Swift Patient Mover

A compact standing aid that facilitates standing and transfers in the home, community and facility environments. Offering a more active transfer solution, users are encouraged to stand up independently, improving circulation, breathing and muscle strength. The Swift Patient Mover is an ideal alternative to a patient lifter for users with appropriate sitting balance, who require transfers over greater distances.

Four user contact points (foot platform, knee pad, seat pads and grip handle) promote stability, support and comfort for the user, resulting in greater confidence in the transfer.

Height adjustable soft knee.

Soft seat pads - swing out of the way to allow user access and swing back into place to provide a comfortable seating surface.

Lockable 75mm castors - the platform remains stationary while a user is transferring, while minimising the leg height for sufficient clearance beneath beds and furniture. Width adjustable legs activated via 2 foot pedals, provide the ability to manoeuvre closer to furniture, toilets or beds for safer access.



<b>Overall Length</b>	<b>820mm</b>	<b>Overall Width</b>	<b>490-760mm</b>
<b>Seat Pad Height</b>	<b>620-670mm</b>	<b>Overall Height</b>	<b>1060mm</b>
<b>Knee Pad Height</b>	<b>250-490mm</b>	<b>Max User Weight</b>	<b>185 kg</b>

21-0400

*Patients stay happy, safe, comfortable and independent in their own homes.*

*Falls in the elderly lead to an increase in the risk of hospitalisation and a significant health decline. As well as physical injuries suffered, the psychological and social consequences of falling can have an equally huge impact. People who fall may suffer depression, anxiety, isolation and loss of independence.*

*Falls are the second leading cause of hospital admissions due to injuries, and many older people never fully recover from their fall.*



Maintaining your duty of care is a lot easier with the Dynamic Falls Prevention suite of products. This state of the art system, offering floor, chair and bed mats, coupled with an alarm monitor is specifically designed for Nursing Home, Hospital or Home Care Environments.

The mats are connected to the alarm monitor by cord, or wirelessly, so that when the floor mats are stepped on, or if the patients weight is fully removed from the chair or bed mats, that the monitor alarms and alerts the carer that patient is moving.

The alarm will be heard in other rooms, allowing you to respond to the alert, and get to your patient to assist them. In many circumstances, the patient will sit back down and wait for the care person when they hear the alert. Once the alarm is silenced the automatic system resets itself, and is ready to alarm again.

### **Features**

- Simple operation and maintenance.
- Adjustable Alarm volume and tone.
- Alerts for low battery.
- Can be connected to Nurse Call system.
- Auto rearm after alarm activation.
- Visual Alarm indicator.
- Reset button. (To Silence the Alarm)
- 1 year manufacturer's warranty on alarm and floor mat.
- Operates on 3 AAA or AA batteries (not inc)

## Deluxe Range

**4107 Monitor**



**4103 Single Fold Floor Mat**

Open dimensions  
900 x 600mm  
Folded dimensions  
450 x 600mm



**2665 Soft Bed Pad**

Soft to touch, comfortable and quiet to use. Easy to clean. Foldable.

- Dimensions 760 x 500mm
- 180 days life expectancy



**4104 Dual Fold Floor Mat**

Open dimensions: 400 x 1200mm  
Folded dimensions: 400 x 600mm



**2633 Premium Heavy-duty Non-slip Floor Mat**

Open Dimensions 1220 x 600mm  
Folded Dimensions 400 x 600mm

## Wireless Range



**2718 Cordless Falls Monitor**

No more cords between monitor and pads. Can be used with two cordless sensor pads or other triggering devices. Monitor can be mounted away from the bed.

**2662 Cordless Bed Pad**

**2661 Cordless Chair Pad**

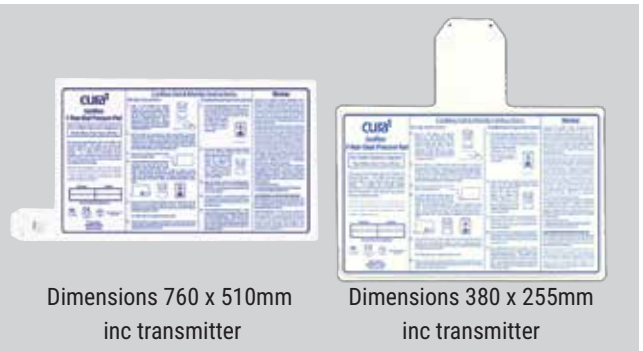

Dimensions 760 x 510mm  
inc transmitter

Dimensions 380 x 255mm  
inc transmitter

**2663 CORDLESS FLOOR MAT**



**Dimensions 1220 x 610mm (inc transmitter)**

Made from heavy duty non-slip material.

- Surface material foam PU (Polyurethane)
- Bottom material PVC without Phthalate

### Early Warning Seat Belt

Activates an alarm if the buckle is released.



910112

### Pull String Alert Monitor

- Alarm sounds when magnet pulls off the monitor.
- Mounts easily to a bed or chair.
- Portable and lightweight stand - alone system.



## Incontinence Monitor Products

This unique range of incontinence monitoring products is reliable and simple to use. With a loud and clear battery operated alarm, the units can easily be cleaned for rapid re-use. (Single patient use is recommended . Pads have a 30 day life expectancy)



**Monitor** 91-CU4020

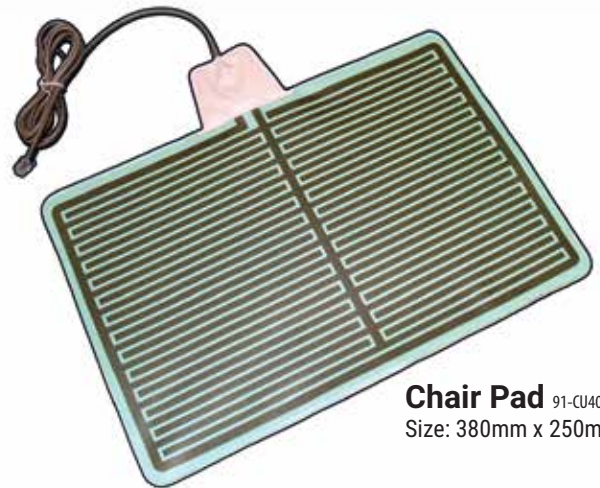

**Chair Pad** 91-CU4022  
Size: 380mm x 250mm



**Bed Pad** 91-CU4021  
Size: 750mm x 100mm

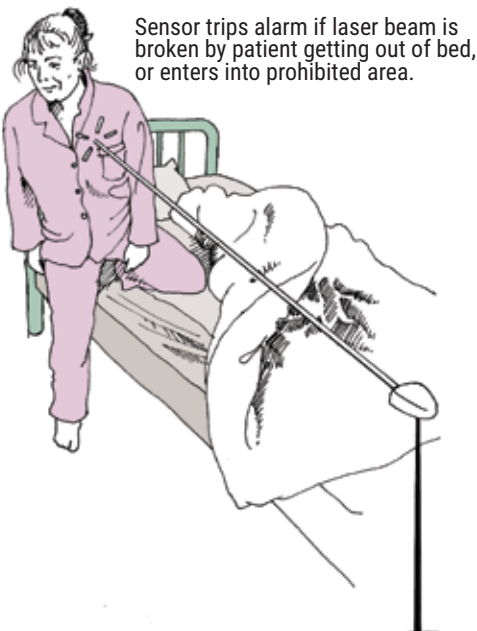

Sensor trips alarm if laser beam is broken by patient getting out of bed, or enters into prohibited area.

# Contenance Products



1  
25CCD085095



2  
2599060090

## 1/Conni Bed Pad

Conni Bed Pads guarantee you a restful night with absorbent, soft and comfortable protection.

Available in two sizes and colours to suit any application.

## 2/Conni Absorbent Mat

The Conni Absorbent Floor Mat eliminates the use of towels on the floor, which can create potential fall risks for people at home with reduced mobility.

## 3/Conni Chair Pad

Conni Chair Pads are placed discreetly on top of the chair, car seat or other furniture.

## 4/Drylife Range

DryLife® uses innovative TENCEL® fibre technology to draw in and trap moisture. DryLife® range of products are great for in the home, car and wheelchairs.

DryLife® products absorb up to 700ml of liquid. Lightweight breathable polyurethane backing. Slip resistant backing fabric. Machine washable and DryLife can be tumble dried.



3  
25CCD051061



4

5-QDLFMC01

DryLife® Floor Mat  
Dimensions 60cm x 90cm.

## Conni Undergarments

Conni washable undergarments are designed to look and feel like regular underwear - fashionable and discreet. Made from soft cotton elastane with a breathable layer of waterproof polyurethane. The thin but highly absorbent core is soft and quiet. We guarantee consistent sizing. You will feel secure and comfortable.



255702

### Conni Mens Oscar

This style is a standard fit front-opening undergarment popular for all ages.



255602

### Conni Ladies Classic

The simple but feminine design is a popular choice for all ages.



255601

### Conni Ladies Chantilly

This Conni Chantilly features pretty stretch lace in front of the leg opening.



255701

### Conni Mens Kalven

Based on the popular boxer short. Made from cotton elastane, with a front opening and heavy duty elastic waist band.

Our range of easy to use amplified phones deliver outstanding clarity. Every product has been designed incorporating ideas and features to help you talk more easily with family and friends. Our Pro series range of phone offer greater amplification, clarity, security, and ease of use than standard phones. Designed to enable user to tailor the level of amplification and sound characteristics for clear and comfortable conversations.

**Key Features of the Pro Series Models**

- Amplified sound technology for louder, clearer communications.
- Enhanced high frequency audio with minimum distortion
- Loud and clear speaker phone
- Talking voice menu on cordless handsets
- Extra loud adjustable ringer with variable tones
- Super bright incoming ring signals
- Easy to see large backlit displays
- Loud and clear message playback
- Personalise handset profiles



**Care 100 Amplified Big Button Phone**

This popular big button amplified phone features a uniquely shaped handpiece together with earpiece amplification making it ideal for persons who are hard of hearing.

**Care 80 Amplified Phone with Picture Dialling**

Features an amplified receiver, extra loud ringer, a large high contrast keypad, bright visual ring indicator and is Hearing Aid compatible. The Care 80 is the perfect phone for persons suffering from memory loss, moderate to severe hearing loss and or low vision.



**Pro910-1**

Cordless/Corded Amplified Phone with Integrated Digital Answering System Ideally suited to persons with moderate to severe hearing loss and/or low vision.



**TP58 Big Button Speakerphone**

This corded phone is ideal for home or commercial use. It is packed with easy to use practical features, it's the ideal phone for people who suffer from low vision. The Oricom TP58 has over size high contrast buttons, large comfort grip handset, 6 one touch memories and speakerphone making it easy to use.



**Oricom Pro 610 Cordless Phone**

This amplified cordless telephone is ideally suited to persons with moderate to severe hearing loss and/or low vision.



**Doorbell and Phone Ring Alerting System**

Never miss a phone call or knock at the door again with the NEW Oricom AM20 Doorbell and Phone ring alerting system



**WakeN Shake – Loud Alarm with Jumbo Display**

The Oricom wake 'N' shake alarm clock is ideal wake up call for persons who are hard of hearing and/or suffer from low vision. Use it as a stand-alone alarm clock or connect it to your phone and it becomes an extremely loud alarm ringer, with flashing strobe light, vibrating shaker and a jumbo high contrast display for easy reading in low light.



A range of highly visible, easy to read clocks aimed to assist dementia sufferers and those with cognitive impairment. Memory loss is often the first symptom to appear in someone suffering from dementia or other cognitive impairment. The use of orientation clocks may assist with this problem. These clocks are suited to people with varying degrees of cognitive impairment with the need to be reminded of the day, time or date.



58-0202

### 1. Analogue Calendar Clock with Automatic Calendar

This clock is popular in the home as an invaluable reminder for day/time. Featuring a 300mm analogue clock-face and day/date calendar, it can be read up to 15 metres distance. Includes a reliable German movement and an automatic calendar function that self-adjusts for leap years. The flip card display remains readable under fluorescent lighting. **DVA approved.**

### 2. Automatic Calendar Clock

This popular calendar clock features a 70mm analogue clock-face and day/date calendar. Includes a reliable German movement and the automatic calendar function self-adjusts for leap years. The flip card display remains readable under fluorescent lighting and can be viewed from 10 meters away. Clock can sit on a flat surface or be wall hung.

**DVA approved.**



580201



580200

### 3. Large Digital Calendar Clock

This Automatic Calendar Clock has an easy-to-read time and date display and the Day-of-the-week is spelt in full. This slimline white clock can be wall mounted or can sit on a flat surface using the built-in stand. There is the option of 12 or 24 hour format and also an alarm function. **DVA approved.**

### 4. WAKE 'N' SHAKE Travel Alarm Clock

The WNS10 is the perfect alarm clock for the time you spend away from home. Shakes you awake with its powerful bed shaker and extra loud pulsating alarm. You will never sleep through another appointment. Includes a handy and durable travel case, take this unit with you wherever you go.



580203



580204

### 5. Digital Clock With 8" LCD Display Available in White and Woodgrain finish

The VISO10 Digital Clock is ideal for Alzheimer's and Dementia sufferers, or those with sight impairment. The clock features a Large 8" LCD display, non-abbreviated display of Day, Date, Month and Year, as well as versatility in mounting options. These features ensure that you are never too far away from being able to accurately read both time and date.

# Safety Illumination



55-0708

### Desktop Lighted Magnifier

A desktop lighted magnifier using cold cathode wide spectrum lighting that uses only 5 watts. Bright, glare free, cool to touch and energy efficient. Provides 3 times magnification and up to 10,000 hours of lighted time. Ideal for reading, craft, needlework, stamps and all applications requiring magnification and light. An electric adaptor is supplied.

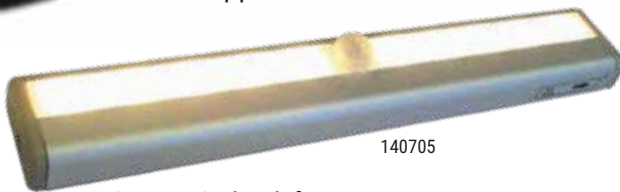

140705

### Sensor Strip Light

A convenient and portable battery operated automatic sensor strip light ideal for use in any low light situation, featuring both motion and light detection sensors.



140706

### Toilet Night Light

A Night Light designed specifically for the toilet featuring motion and light sensors to help prevent falls in the bathroom. With 8 different colour choices or an auto colour sequence mode, the night light is placed on the edge of the toilet bowl and lights up when motion is detected in low light situations. This reduces the chance of falls, spills and accidents and improves safety in low light situations. The Toilet Night Light requires 3 x AAA batteries (not included).

## Room Lamps



### MultiFunction LED light 140703

- 3 in 1 light with bright LED
  - Automatic night light.
  - Portable rechargeable torch
  - Power failure backup light
  - 5 hours lifespan on single charge
- DVA approved**



### Portable Sensor Light 140704

- Stationary light or portable torch.
  - Motion and low light sensors.
  - Battery operated or run off mains.
  - Power adaptor also included
- DVA approved.**



### Touch Lamp 140700

- Easy touch for on/off..
  - Shatter proof lamp shade.
  - 11 watt bulb for great lifespan.
  - Operates on mains power.
- DVA approved**

# Personal Alarms

## Mindme Pro SOS & GPS Pendants

The MindMe Pro SOS & GPS alert pendant keeps the wearer in touch with family and carers whether they are at home or out and about.



### Suitable for

- The Elderly
- People with disabilities
- People in early stages of Alzheimer's and dementia
- Those concerned with personal safety

### Package includes:-

- Mind Me Unit
- Docking Station
- User Guide
- Charger
- Lanyard
- SIM Card



### Features of Mindme Alarm

- Size 60mm x 44mm (wide) x 14mm and weighs 40 grams.
- Uses a multi-network SIM chip (instead of a SIM card) as long as a mobile network exists the device will remain connected.
- Uses GPS to work out its location - accurate to 10 metres.
- Sends location to Mindme secure servers around every 3 minutes. 10 minutes when stationary.
- Pressing the button and using GPRS the alarm connects quickly to Mindme's 24/7 Response Centre
- Two-way voice communication ensures the right help is available quickly.
- Battery lasts up to 48 hours.
- Simple to use charging unit with no fiddly connections.
- System sends e-mail when battery is under 10% capacity.
- Ring fence option available – alarm will be tripped if user moves outside pre-set locations.



#### Fall Detection

When a fall is detected and the wearer does not move for 10 seconds, Mind Me will automatically send an SMS alert to the emergency contacts.



#### One Button Operation

When the SOS button is pressed Mind Me will send an SMS to the emergency contacts with a Google Maps link and then ring the contact numbers until the call is answered.



#### 2-Way Hands Free Communication

When an emergency call is answered, the wearer and the contact can have a 2-way conversation. The contacts can also ring the Mind Me alt any time to talk to the user.



#### Built-in GPS

When the SOS button is pressed, an SMS and a link to Google Maps is sent to the contacts. When the link is pressed the location of the wearer is shown on Google Maps.



#### Use in home or when out & about

Mind Me works wherever a mobile phone or GPS works. Whether the wearer is at home or out and about, they will always be in contact with the family or carers.



#### Geo-Fence

If the wearer tends to wander, a geo-fence (boundary) can be set up so when the fence is breached a SMS alert is sent to the contacts-

## Mind Me Watch



The MindMe Watch combines a watch, mobile phone and GPS device to assist individuals seek assistance in an emergency, giving the wearer confidence and independence by keeping them in touch with family and carers whether at home or out and about.



55-0705



55-0702

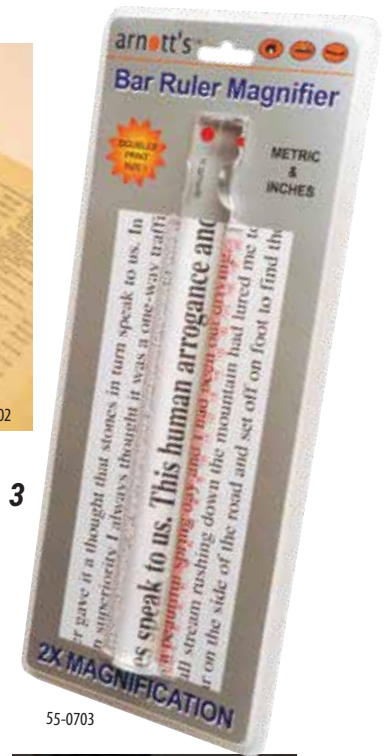

55-0703



55-0706



55-0712

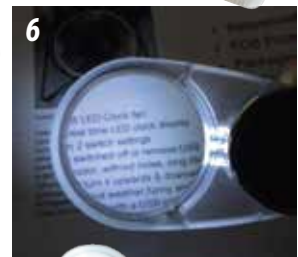

55-0710



55-0704

**1/ 13cm Circular Handle Magnifier with LED Light**

The Sherlock Holmes of magnifiers. A large 13cm Handle Magnifier with LED Light, ideal for reading maps, directories, menus, stamps and any small print in all lighting situations. Providing 2 times magnification with a 6 times spot lens. Measuring 26cms in length.

**2/ The 5X Magnifier with 3 LED Lights**

A powerful 5x magnifier with 3 LED Lights to illuminate & enlarge any surface. Can even double as a paperweight. Ideal for a number of applications for all ages. Comes with a cleaning cloth & sturdy storage pouch.

**3/ Bar Ruler Magnifier**

A 20cm ruler and magnifier all in one. Place on a sheet to receive 2 times magnification to double your print size. Metric and inch scales.

**4/ Acrylic Rectangular Magnifier**

A lightweight rectangular handle magnifier that provides 2x magnification with a 6x spot lens. Ideal for reading small print, contracts, telephone directories, maps, coins, stamps and more.

**5/ Wide Screen Inclined Magnifier**

X's Magnification. 4 LED's with inclined lens. Batteries included.

**6/ Foldable LED Magnifier**

Bright LED light, 3X's magnification. 2 x CR2016 batteries included. Swing Open lens to turn on LED.

**7/ Acrylic Dome Magnifier-60mm diameter**

An acrylic, unbreakable 60mm magnifier that rests directly on the reading surface, providing a large viewing area with optical clarity. It collects ambient light to illuminate the subject thus reducing eye strain. Doubles as a paperweight. Comes with a storage/cleaning pouch.

# Perfect Petzzz®

Provide much needed comfort for people of all ages and abilities, especially those in hospitals & care homes. Reduce stress levels, loneliness, anxiety, agitation & depression.

A wonderful way for grandchildren and adults alike to engage with their loved-ones who are living with dementia. The Perfect Pet to feed the need to nurture, love and be loved.

- ♥ Proven positive psychological impact.
- ♥ Help reduce stress levels, loneliness, anxiety, agitation & depression.
- ♥ Promotes relaxation, motivation & improved socialisation.
- ♥ A wonderful way for grandchildren and adults alike to engage with their loved-one who is living with dementia.
- ♥ Life-like cuddles for companionship and comfort with the perfect pet!



Chihuahua



Cavalier King Charles



Black Labrador



Cocker Spaniel



Beagle



Border Collie



Alaskan Husky



Collie



Boxer



Chocolate Lab



Bulldog



Orange Tabby



Black & White Shorthair



Grey Tabby



Calico Cat



BUNDLE

## Features

100% synthetic and contain no animal fur. Powered by 1 D-cell battery.

Bundle includes: Brush, Bed, Cardboard Carrier, Instructions, Adoption Certificate



Collar

**Not suitable for children under 3 years old**

# Dressing & Grooming

Our huge range is designed to provide greater independence while performing simple tasks



- 1/ Stocking Aid
- 2/ Sock Notch
- 3/ Terry Cloth Sock Aid
- 4/ Tights Aid
- 5/ Button Hook
- 6/ Coiler Elastic Laces
- 7/ Ezy-Ups
- 8/ Toe Nail Scissors
- 9/ Dressing Stick
- 10/ Plastic Shoe Horn
- 11/ Long Handled Comb
- 12/ Long Handled Brush

## GripSox®

GripSox® have helped more than 120 hospitals and aged care centres dramatically reduce their falls incidence rates

GripSox® are also ideal for exercises such as pilates, yoga, hydrotherapy, trampolining and water sports.

### GRIPSOX® SPECIAL FEATURES:

- 95% cotton for breathability.
- 5% elastane for extra stretch.
- Non-cushioned sole for better proprioceptive feedback & grip sensation.
- Thick density grip dots for enhanced grip effect.
- Latex free.
- Seamless toe for comfort.
- Fitted heel prevents sock rotation around the foot.
- Increased warmth, safety & hygiene.
- Easily worn over compression stockings.
- Grip dots withstand high temperature laundering.
- Available in all sizes (2-8, 6-11 & 11-14)



## Etac Beauty & Body Care products

Our ergonomically designed Bath & Beauty products make everyday activities like showering and combing hair easier by combining maximum power and reach with minimal strain on your hands, arms and shoulders.



99-80210068



99-80210072

**Beauty Hairbrush and Beauty Comb.** Available in two lengths, the shorter version is recommended when the user can reach up to the ear. The longer version is suitable for users who only can reach to the shoulder. Both the brush and comb are curved for the best comfort and control when combing/brushing the hair.



99-80210080



99-80210076

**Beauty Body and Back Washer.** Designed to make it easy to reach and wash the body. The wash cloths do not absorb water which make the products light and balanced even when wet. The handles are oval and have a surface which enables a secure grip. The wash cloths are machine washable and replaceable

**Beauty Hair Washer.** Substitutes the fingers to apply shampoo and massage the scalp. The shaft and handle are of the same design as the body washer, making it easier to reach the head without strain on the hands, shoulders or arms.



**etac**<sup>®</sup>  
Creating Possibilities

# Independent Eating

## ELISPOON

A revolutionary spoon that enables independent eating for people with hand coordination difficulties such as Cerebral Palsy, Spinal Cord Injury, or Post-stroke deficits. It keeps the spoon bowl level regardless of how your hand or arm twists or moves, preventing food spillage. No electrical components or batteries, making it easy to use and easy to clean. Dishwasher Safe.



We have an extensive range of eating and drinking aids. Providing practical solutions for eating and drinking including a variety of cutlery, cups and accessories. Depicted are just some products in our range.



56AA5510

Kings Modular Cutlery



56AA5550

Lightweight Cutlery



57A703200

Supergrip Cutlery



56AA5570

Caring Cutlery



56AA5240

Reflex Knife Set



56AA5500

Queens Cutlery



56AA5710

Caring Mug



56AA5700

Clear Polycarbonate Mug



56AA5597

Nelson Knife



57C1425

Inner Lip Plate



56AA5662

Incurve Plate Surround



56AA6810

Dycem Non Slip Mats

Available in number of shapes and sizes



56AA5570

Kettle Tipper



No-nonsense kitchen and household aids to assist with daily living, including cooking baskets, peelers, preparatory workstations, openers, tippers, scissors, turners, non-slip materials and more.

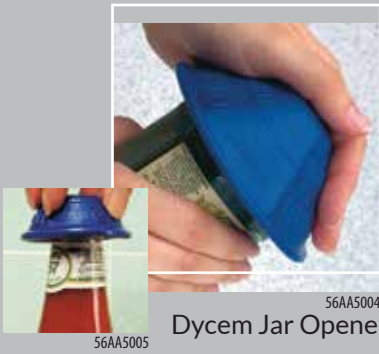

Dycem Bottle Opener



Can Pull  
56AA5194



Jar Opener  
56AA5000Y



6-in-1 Multi Opener  
56AA5587



Undo-it Jar & Bottle Opener



Bread Board Hardwood with Lid



Kitchen Work Station



Plastic Spread Board



Belly Clamp



Bench Peeler



OXO Good Grips  
Winner of the Tylenol/Arthritis Foundation Design Award

## Tap Turners



## ONE TOUCH™

One touch products open all standard sized bottles, Cans and Jars with just the one touch. Runs on AA sized alkaline or rechargeable batteries.



# SaeboGlove



This cutting edge device helps clients suffering from neurological and orthopaedic injuries incorporate their hand functionality in therapy and at home. The lightweight, low-profile functional design is just one of the many innovative features that are offered with the Saebo Glove.

The proprietary tension system extends the fingers and thumb following grasping so clients can incorporate their affected limb functionally. This new found freedom leads to improved motor recovery and functional independence.

## Features:

- Spiral forearm design that secures the wrist in a functional position.
- Tensioners are located at the IP points (*interphalangeal Joint*) of the fingers and thumb to assist with the extending the digits following grasping.
- Individual tensioners can be removed to customise assistance based on the client's needs.
- Numerous sized Tensioners included to accommodate various finger lengths.
- Full joint finger motion enables maximum functional performance.
- Silicone covered fingertips to improve traction during grasping.
- Non-slip liner to minimise migration.
- Glove includes Lycra material for expandability.
- Palm exposed to increase breathability and ease of donning.
- Lightweight and comfortable.



◀ The **SaeboStretch** is a revolutionary hand splint for individuals suffering from neurological injuries such as stroke. The splint helps to prevent joint damage while improving and maintaining range of motion.

The SaeboStretch allows the fingers to move through flexion caused by postural changes, associated reactions and increased tone. It then gradually repositions the fingers into extension. It includes three different hand pieces that offer various grades of resistance.



◀ The **SaeboStep** is a lightweight, uniquely designed foot drop brace that provides comfort while offering optimum foot clearance and support. Designed to replace uncomfortable, stiff, or bulky splints that go inside the shoe that lack support and durability.

**For a consultation appointment, please call:  
Statewide Home Health Care or Peninsula Home Health Care  
9591 6234 9786-7004**

## Kitchen Trolley

Ideal for use around the house at meal times. Sturdy powder coated steel frame complete with two removable plastic trays and mounted on four 75mm swivel castors. This product offers everything that is needed in an easy to use mobile tray.



130102

## Kitchen Stool

Stools are an ideal "energy saver" for use in the kitchen or similar work area where a standard chair is not suitable or the user has difficulty standing or sitting.



130203

## Safe Transferring

### 1/ Swivel Cushion

The Swivel Cushion Easy Turn may be used when entering or exiting a vehicle to assist in a pain free transfer. Use in combination with the Handy Bar for added assistance.

### 2/ Key Turner-Single & Double

The Key Turner has a curved, heavy duty plastic handle that provides extra leverage to turn keys.

### 3/ Homecraft Single Leg Lifter

### 4/ Handy Bar

The Handybar™ offers support to help you out of the car safely and securely.

### 5/ Double Leg Lifter

The leg lifter helps people to lift their legs onto or off a bed.



2

56AA6242Y

56AAG24Z



1

200301



3

55-0509



4

200701



5

2327

## Reaching Aids

Perfect for reaching and retrieving a variety of items in the home or garden. Available with a range of features and various operating triggers to suit different levels of hand function.

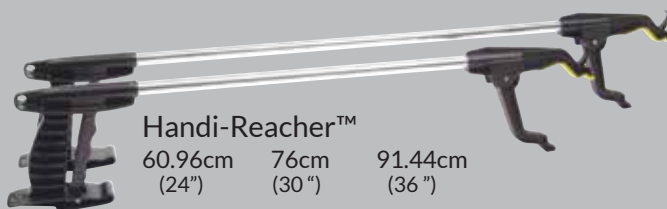

### Handi-Reacher™

60.96cm 76cm 91.44cm  
(24") (30") (36")

56AA8054 (24) 56AA8056 (30) 56AA8058Y



### Pick-up Reacher

60.96cm 76cm 91.44cm  
(24") (30") (36")

56AA8060 56AA8063 56AA8073

### Premium Reachers

67.3cm 82.2cm  
(26.5") (32")

550501 550502

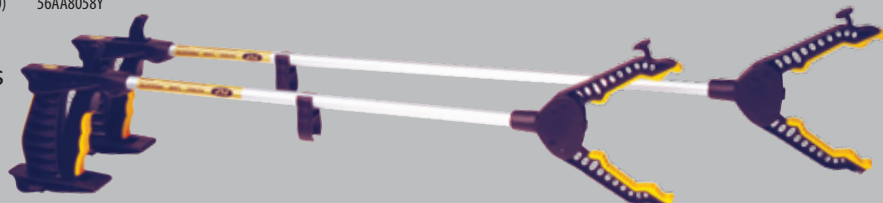

A comprehensive range of dumbbells and accessories are available. Ideal for low-impact exercise right through to a regimented fitness program. Weights start from 0.5kg



**Squize Ball** 95-0901

Squize balls build strength in fingers, hands, arms and shoulders. They help to achieve stronger grip and improve wrist strength. Ergonomically designed to the shape of a squash ball, they fit perfectly in the palm of smaller hands or between fingers. Choose from 3 strengths; soft, medium or hard.



**Exercise Putty**

Putty can be used in therapy to improve grip strength, dexterity, and hand strengthening through finger, hand and wrist resistive exercises. Each colour-coded putty comes in different consistencies

**Fitness Ball**

Fitness ball has been scientifically proven to improve both your posture, core strength and your overall balance and stability. Fitness Balls are also often used in rehabilitation and in the treatment of back pain.

Available in: 55cm, 65cm & 75cm

**Yoga Mat**

Used during Yoga or any other exercise, Yoga Mats are used to improve balance and can also aid in the prevention of injuries that can be caused by otherwise slippery surfaces.



Available in:  
1720 x 610 x 4mm  
1820 x 610 x 6mm

950701 950702



950210

**Vinyl Dumbbells**

Vinyl Dumbbells are perfect for a variety of individual and group workouts, including jogging and power walking, aerobics, general exercise, physical therapy and even yoga routines. These easy to grip, easy to clean Vinyl Dumbbells are colour coordinated and available in 0.5 incremental weights ranging from 0.5kgs to 10kgs.

**Exercise Mat**

Manufactured from a closed cell material that is resistant to moisture. The exercise mat is a great accessory for any user who gets a sore back when performing floor exercises. Ideal for use in aerobic, yoga and pilates classes.

Available in: 1800 x 1200 x 20mm  
1800 x 600 x 10mm



950703

950704

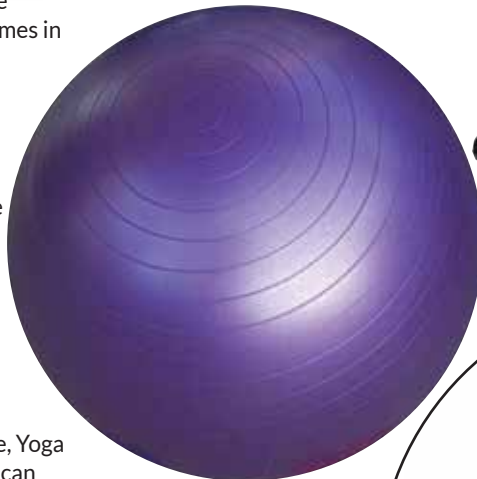

950101



**Exercise Bike**



**Exercise Pedals**

951001



96-T4085

**Thera-Band® Door Anchor**  
Simply insert this anchor into the pull side of a door, completely close and latch the door, and your TheraBand is ready for action.



**Therahandles (2)**

Comfortable, good quality handles to assist exercising with resistive bands and tubing. Foam covered handle for a better feel.



96T7785

**Thera-Band® Exercise Bands**

Thera-Band® latex Exercise Bands are used for resistive exercise. They provide both positive and negative force on the muscles, improving strength, range of motion and cooperation of muscle groups. Colour-coded progressive resistance gives at-a-glance documentation of progress from one level to the next.



95-0501

**Resistance Stretch Band**

By using a resistance band or tube, you can deepen your stretch and increase your flexibility. The resistance band allows you to change your positioning in multiple ways. This changes how your body works and how an exercise feels.



950228

**Footsure® Vinyl and Leather Ankle Weights**

Footsure ankle weights are less bulky, making them extremely comfortable during use. Velcro fastening allows you to wrap one weight over another or use as wrist weights.



950218

**Adjustable Ankle Cuffs**

By being able to increase the weight of the cuff from 0.5kg all the way up to 10kg, this allows greater flexibility in what you can achieve. (0.5 kg weights sold separately in packs of 10)

**massage**

**Index Knobber**

Developed as a device to be used by practicing, hands-on therapists. Therapists who use The Original Index Knobber II to treat patients find it extremely helpful in applying precise pressure to soft tissue trigger points.



950803

**Jacknobber**

The knobs at each of its four points can be used to apply pressure to muscular trigger points. The smaller knobs are used to give deep pressure while the larger knobs are used to apply gentle pressure.

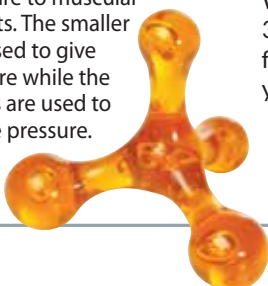

**Backnobber**

The Original Backnobber® II is used by hooking the device over a shoulder or under an arm and using its leverage to apply deep pressure to trigger points in the muscles of the neck, shoulders, upper and lower back. This pressure can significantly reduce tension and pain in soft tissue and increase the range of motion and overall function.

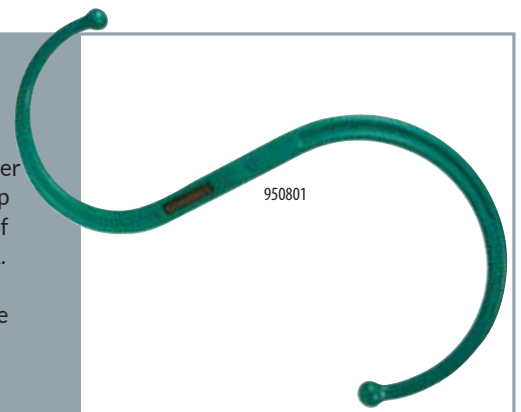

950801

**Wobble Board**

Improve your balance and co-ordination and increase your range of motion with the Wooden Wobble Board. The base allows 360° of movement. The board features non-slip traction to help you keep your grip.

950301



Decreasing pain and enhancing human performance through extraordinary innovation, education and service.

Premium Bracing is the result of combining innovative designs and a firm understanding of biomechanics, with materials that have been designed specifically for sports medicine applications.

Bioskin® is your choice for premium compression bracing.

### Bio Skin® Thumb Spica

This ultra low-profile brace protects the thumb from unwanted motion while allowing full range of motion in the other digits.



### Bio Skin® Cock up Wrist Skin

The DP2™/DP3™ Cock-up wrist brace was designed to be the most comfortable and functional wrist-brace ever. The dorsal and palmar stays are removable and can be reshaped by hand to customise the shape of the brace.

The low-profile brace allows full use of your fingers while limiting motion in the wrist to ease the pain from carpal tunnel syndrome, arthritis, sprains, and bursitis.

### Bio Skin® Boomerang™

The Boomerang comfortably provides compression and support for minor wrist problems. The wrap is easy to apply and fits onto either hand.



### Bio Skin® Wrist/Thumb Spica

The brace protects the thumb and wrist against painful movement by controlling the motion of the CMC and Mp joints, while allowing full use of the fingers.



### Bio Skin® Hinged Knee Skin™

The Skin® Hinged Knee Skin™ Is the lightest hinged knee brace available. The offset, bicentric hinges conform to the shape of the leg and provide extra support to knees with ligament damage. Constructed from Bio Skin's® unique, breathable materials, the Hinged Knee Skin™ also provides excellent compression to control swelling and pain and to speed healing in a damaged joint. Wrap-around design allows for easy application.

- Front Closure application
- Offset hinge reduces pressure at the knee joint
- Unique strapping system minimises migration
- Donut and horseshoe buttresses can change position to allow custom patella support



### Bio Skin® Standard Knee Skin™

Bio Skin's™ Standard Knee Skin™ gives optimal compression for pain reduction, swelling control, and increased proprioception.

### Bio Skin's® Visco Knee Skin™

Bio Skin's® Visco Knee Skin™ is an excellent all-purpose knee brace. The Visco gel ring around the patella provides passive massage to remove swelling and decrease pain.



### Bio Skin® Q Brace™

The Q Brace™ has a unique design which allows multi-directional traction of the patella. The "T" strap prevents dislocation and may be attached in various positions to control the direction of traction on the patella. The design of the brace causes the force of traction to increase as the knee goes through a range of motion.

Bioskin® is a unique, patented material designed to provide high level compression without creating discomfort. Bioskin® is thin and gives radial compression so it conforms nicely to the curves of the body. Bioskin® is also breathable, so perspiration evaporates right through it, it is hypo-allergenic so you don't have to worry about skin reactions. These characteristics make wearing Bioskin products a surprisingly satisfying experience.

- Breathable
- Light
- Hypo-allergenic
- Latex Free
- Durable
- Thin
- Odourless
- Machine washable
- Strong
- Neoprene Free

### Bio Skin® Tennis Elbow Band

The Tennis Elbow Band fits comfortably below the crease of the elbow and includes a silicon pad and an elastic strap that may be positioned to provide extra compression and pain relief.



### Bio Skin® Standard Elbow Skin

The Standard Elbow Skin™ keeps you cool and dry while providing outstanding compression for pain management.



30B42100

### Bio Skin® The Q Baby™

The Q Baby™ wraps comfortably around the knee, just below the patella, and includes a uniquely shaped silicon pad that fits over the patella tendon to give pain relieving compression for patella tendonitis and to increase surface contact area in the joint.



30B51650

### Bio Skin® Standard Ankle Skin™

Bio Skin's® Standard Ankle Skin™ is an economical way to control swelling and support ankles with minor instability.



30B53500

### Bio Skin® Calf Skins™

Bio Skin's® Calf Skins™ give excellent compression to ease the pain in injured calves or shins. The unique SkinLok™ feature of the Bio Skin® material mean the sleeve won't slide down the leg, even during vigorous activity.



30B46300

### Bio Skin® Trilok

Whether you're looking for a brace to protect an ankle you've already injured or you're hoping to prevent an ankle injury, Bio Skin's® TriLok™ is the most effective brace for controlling inversion, eversion, and plantar flexion inversion. No other brace offers more stability, comfort, and safety.



30B53601

### Bio Skin® Flexible support

Provides multi-directional support. Choose one of two placement options:



### Bio Skin® Backskin Lumbar Pad

Offers a broad variety of pad positions to fit directly over the pain.

### Bio Skin® Backskin™ system

Treat lumbar sprains, pain from overuse, muscle strains, and develop better back posture. We've designed our back brace with a narrow cut in the front and flexible stays on the sides so when sitting or bending the brace remains pliable and doesn't impinge on the groin area or into the rib cage.

Customize your treatment with these lumbar support options:



30B47200

# Back Supports

We stock an extensive range of therapeutic pillows. Drop in, try the back support in your car, or the sleeping pillows on our range of mattresses.



650233

### Back Eze MK2

The Back-Eze Moulded support cushion range are lightweight, portable and retains their shape to last for years.



650203

### Back Eze Standard

### Total Spinal Support

Full-length back support featuring flanks for added lateral support. Ideal for car or lounge.



650215



650227

### Bassett Lumbar Support

Perfect for the bed, floor, or couch. You can use it anywhere you choose.



650204

### Back Form Support

Supportive flanks and tapered back corners to compensate for curved car bucket-type seats.



650201

### Back Hugger

Versatile Lower back support that features inbuilt spinal support column to snugly fit into the back.



650211

### Koala Komfort

Perfect for the bed, floor, or couch. You can use it anywhere you choose.



### Lumbar Rolls

Compact for car, bus, office, plane. Available in traditional or memory foam. Four shapes to choose from: Round, Egg, D or Oval.

## Positioning Aids



650427

### Quad Cushion

High quality multi-use supportive cushion to help your comfort in many positions



650409

### Leg Spacer

Memory foam support ensures legs and hips are aligned with your spine.

## TRAVELLING PILLOWS

**Peanut Pillow**  
Handy neck support for car, couch or beach.



**Travel Pillow**  
Ideal support of neck and head whilst sitting or travelling.

THE THERAPEUTIC PILLOWS



## Keyhole Cushion

Post-natal or post-operative relief. Keyhole Cushion is a high density cushion with a symmetrical aperture. Designed for post-natal or post-operative discomfort, haemorrhoids, bruised coccyx and other painful conditions.



65-0313



65-0322

## Ring Cushion (right)

The Multi-Purpose Cushion uses premium convoluted traditional high density foam to disperse pressure.



## Coccyx Diffuser 650301

Relieve tailbone pain and reduce pressure on your coccyx.



## Posture Wedge 650320

Helps in maintaining the spine's natural curvature, and assists in alleviating nerve pressure in the mid-back area.



## Diffuser Cushion 650303

An premium Australian made density pressure relief cushion made from memory foam with a special inner core of heavy density traditional foam.



## Multipurpose Cushion 650315

Spreads body load by providing less contact area and reduced pressure for greater comfort. Won't 'bottom out'! Ideal for anyone sitting for long periods.

## Sleeping Pillows

### Naturelle Pillow™

(low, medium, high)  
Luxurious pillow in natural latex rubber - From the rubber tree. Therapeutically designed and gently contoured pillow



650112

### Complete Sleeprrr™

Therapeutically designed with two easily removable/re-workable inserts allowing you to change the shape and height to suit your comfort and postural needs.



650101

### Tranquillow

Carved from non-allergenic quality foams in different densities and softness. Specifically designed to support the neck and cradle the head.



650119

## Bed Pillows

### Side Snuggler

Maintain a comfortable and safe side sleeping position during the last two trimesters for Mothers to be.



650431

### Pyramid Pillow

The only relaxation support pillow featuring the patented Lumber Bulb for additional lower back support.



650501

### Bed Wedge & Leg Relaxer

Ideal for those suffering medical conditions requiring an angled sleeping position. Designed to help those with asthma, bronchial or breathing constraints, and other medical problems.



65-0401

65-0410

# Heat Wheat

The grain used in the manufacture of Heat Wheat® products is treated with our exclusive Ultrashield™ process to be free from weevils, mould, allergenic dust and moisture induced growth. This unique seven-stage treatment process gives the wheat superior temperature retention properties and makes it durable enough to go from freezer to microwave for years.

The products mould comfortably to the body and provide penetrating warmth (or cold) to injuries or chronic conditions such as arthritis, migraine, muscle tension, spasm and joint pain. The products also induce relaxation and give comfort with warmth.



500207

**Physio Pad**  
Available in small and large



500213

**Joint Wrap**



**Eyezone**  
500224

**Hand Glove**  
500216



**Shoulder Cuff**  
500220



**Oval Cushion**



**Neck Warmer**  
500205



**Back Support**

500217



500206

**Neck & Back Therapy Wrap**



500221

**Slippers**



500222

**Upper Body Wrap**

HEALTH & WELLBEING

# Vulkan Range of Sports Bracing

Vulkan has been a trusted name, innovating the market in braces & supports for 40 years. Now Vulkan continues that tradition with the introduction of Vulkan Professional Orthopaedic range to the Vulkan brand family. Vulkan Professional Orthopaedic range offers a comprehensive selection of quality supports to meet the exacting requirements of health professionals. The Professional Orthopaedic range has the largest selection covering all anatomical areas and offers both universal and broad size ranges, designed for most injuries, conditions or postoperative support. A combination of closed cell neoprene construction and elastic materials helps retain heat at the site of injury for faster recovery.



30-VLK-1188

## Wrist/Thumb Support

Wrist Thumb Support provides superior support and stability to thumb with mouldable thermoplastic insert. 6" (15.2cm).

30-VLK-36

## Elastic Ankle Support

The Vulkan Advanced Elasticated range is the latest innovation in lightweight supports. Provides uniform support & compression, but has unique heat retaining properties that increase blood flow around the joints during activities to speed up the natural healing process. Available in pink & black.

## Stability Ankle Brace

Vulkan Stability Ankle Brace provides high level stability and protection to ankles prone to rolling or twisting. Ideal support during sports and post injury.

30-VLK-4005



30-VLK-1790

## Ice Bag Wrap

Features a removable 20cm (9") ice bag with adjustable wrap for knee; can also be worn on elbow or ankle. Neoprene wrap holds ice bag in place and provides support. Universal size, fits most.

30-VLK-1072

## Shoulder Support

This is a closed cell neoprene support with compressive and proprioceptive effect to retain warmth whilst increasing blood circulation. Latex free.

**VULKAN**  
PROFESSIONAL  
ORTHOPAEDIC RANGE

# Beurer Health & Well-being

Beurer combines German design and engineering with state-of-the-art technology to produce market-leading products for the health, wellbeing and beauty sector. With their innovative products Beurer have become internationally renowned and have won multiple prestigious awards



## Shiatsu Back & Neck Massager

The rotating massage heads imitate the pressure and kneading of a traditional Shiatsu massage.



590019

## Dual Air Humidifier

Enjoy the best indoor comfort and health through hygienic and bacteria free water vaporisation.



## Personal Heat Pad

3 temperature modes offering warmth and comfort, pampering your senses.



590027

## Mini Massager

3 illuminated massage heads work in unison, vibrating and helping to work out muscle knots



590017

## Mini Personal Humidifier

Perfect for your office or for travel, this Mini Air Humidifier is quiet enough to also be used in the bedroom.



590026

## Air Humidifier with Aromatherapy

A perfect solution in dry conditions, when air conditioners and heaters are drying the air.



**Foot Bubble Spa**

The Beurer Aromatherapy Foot Spa has 3 built-in functions: bubble massage, vibration massage and water heat retention. The foot spa features removable roller fittings for massaging your feet's reflex zone.



590012



590004

**Multi-Function Thermometer**

10 memory spaces this instrument allows you to view date, time, and measurement with ease.



590005

**Non Contact Thermometer**

Used for measuring body temperature without making skin contact. Ideal for babies and small children.



590013

**Tens to Go Pain Relief**

TENS nerve electro-stimulation technology, for targeted pain relief without medication.



590014

**Tens to Go Replacement pads**



590015

**Back Belt with Tens**

Flexible and adjustable with Velcro fastening for electro stimulation for back pain relief.

# Stockings & Aids



The Butler Off (doffer) helps to maintain independence by simply using the hook on the top of your sock or stocking and push directly down the leg and over the heel.

550127



**Stocking Donner Stand**  
Designed to make donning compression stockings easier and protects against tears and runs that can occur applying hosiery by hand. Recommended for those with limited dexterity.

550105L



550101

550104

The Ezy-As is designed to be used by people who are unable to apply their own stockings. This Garment Applicator is compatible with open and closed toe and knee high and full leg stockings, tubular bandages, anti-embolism stockings, arm sleeves and gauntlets. Available: Small, Medium and Large.

550102



**Ezy-As™ Handle Attachment**  
Accessory to aid solo fitting, Ezy-As™ also supply a handle attachment (sold separately), clips onto the base of the applicator, and once loaded is used to help pull the garment up a leg.)

## Graduated Compression Stockings



Healthy legs are essential for good quality of life. Whether your vascular care is for a pre-existing condition or to help prevent vascular problems, we stock an extensive range of graduated compression stockings. Graduated compression stockings improve circulation by applying measured pressure on the leg muscles. These muscles compress the veins, improving the flow of the blood back to the heart so there is less swelling, tiredness and aching in the legs.

Our Range includes:

**Light Compression (15-20 mmHg):** Minor foot, ankle and leg swelling, leg heaviness and fatigue due to varices, mild varicosities without oedema, helps prevent thrombosis (inc. Travel-related DVT), help prevent varicosities during pregnancy.

**Moderate Compression (20-30 mmHg):** Moderate to severe varicosities including pregnancy, leg heaviness and fatigue due to varices, varicose veins during and after pregnancy, post sclerotherapy, helps prevent thrombosis, helps prevent recurrence of venous ulceration, oedema and superficial thrombophlebitis.

### Venosan Athletic Unisex Socks

Venosan's selection of unisex sock products are ideal for exercise, travel or daily living. Cushioned foot beds and balloon toe pockets, provide day-long benefits of comfort and relief from the effects of venous disease and/or daily living.



3541032



St Kilda Home Health Care

PAM BYRNE & RODNEY COHEN  
Invite you  
to

The Opening, by John Callanan,  
Mayor of St Kilda  
of their new

HOME HEALTH CARE OUTLET  
at

209 Barkly Street  
St Kilda 3182

between 10.30 & 11.30am  
on

Saturday 15 Feb 1992

RSVP  
Wednesday 12 Feb 1992  
209 Barkly St  
ST KILDA 3182

## The Rodney P Cohen Award

Faculty of Pharmacy and  
Pharmaceutical Sciences  
Monash University Parkville.

Sponsored by the Cohen family,  
the award will be given to the fourth  
year student in the Bachelor of  
Pharmacy (Honours) or Bachelor  
of Pharmacy (Honours)/Master of  
Pharmacy who achieves the highest  
average mark across the Professional  
Practice units.



Rodney P Cohen  
1942 - 2010.

1964 to 2003  
1972 to 1996

Pharmacist in St Kilda.  
Pharmacy Guild of Australia (Victorian Branch)  
(Vice President 1978 to 1996)

1981 to 2008  
1992

Pharmacy Board of Victoria (President 1989 to 1993)  
Founded St Kilda Home Health Care



## Independent living and rehabilitation equipment

- Mobility
- Powered Mobility
- Bathroom
- Toileting Solutions
- Bariatric Products
- Paediatric Products
- Electric Beds and Mattress
- Skin Protection and Comfort
- Bedroom Accessories
- Seating
- Patient Transfer
- Falls Prevention
- Alarms and Communication
- Magnifiers
- Aids for Daily Living
- Dementia Care Products
- Dining and Kitchen
- Fitness and Massage
- Therapeutic Pillows

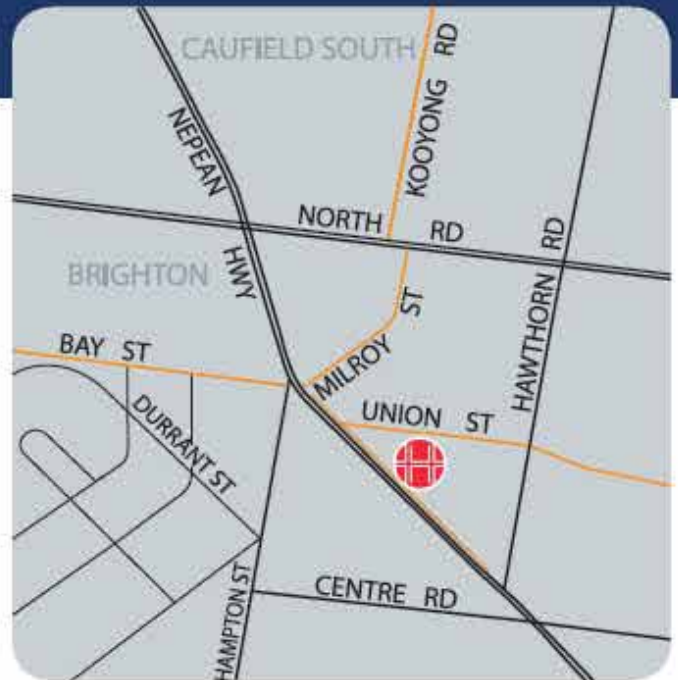

501 Nepean Highway, Brighton East 3187  
T. 9591 6220 sales@shhc.com.au



21 Sir Lawrence Drive, Seaford 3198  
T. 9786 7004 sales@phhc.com.au



REGISTERED  
NDIS  
PROVIDER

[shhc.com.au](http://shhc.com.au)

@shhc\_cares @StatewideHomeHealthCare  
 @Statewide Home Health Care